

CHAPTER 400 – INTERSECTIONS AT GRADE

Intersections are planned points of conflict where two or more roadways join or cross. At-grade intersections are among the most complicated elements on the highway system, and control the efficiency, capacity, and safety for motorized and non-motorized users of the facility. The type and operation of an intersection is important to the adjacent property owners, motorists, bicyclists, pedestrians, transit operators, the trucking industry, and the local community.

There are two basic types of at grade intersections: crossing and circular. It is not recommended that intersections have more than four legs. Occasionally, local development and land uses create the need for a more complex intersection design. Such intersections may require a specialized intersection design to handle the specify traffic demands at that location. In addition to the guidance in this manual, see Traffic Operations Policy Directive (TOPD) Number 13-02: Intersection Control Evaluation (ICE) for direction and procedures on the evaluation, comparison and selection of the intersection types and control strategies identified in Index 401.5. Also refer to the publication Complete Intersections: A Guide to Reconstructing Intersections and Interchanges for Bicyclists and Pedestrians for further information.

Topic 401 – Factors Affecting Design

Index 401.1 – General

At-grade intersections must handle a variety of conflicts among users, which includes truck, transit, pedestrians, and bicycles. These recurring conflicts play a major role in the preparation of design standards and guidelines. Arriving, departing, merging, turning, and crossing paths of moving pedestrians, bicycles, truck, and vehicular traffic have to be accommodated within a relatively small area. The objective of designing an intersection is to effectively balance the convenience, ease, and comfort of the users, as well as the human factors, with moving traffic (automobiles, trucks, motorcycles, transit vehicles, bicycles, pedestrians, etc.). The safety and mobility needs of motorist, bicyclist and pedestrians as well as their movement patterns in intersections must be analyzed early in the planning phase and then followed through appropriately during the design phase of all intersections on the State highway. It is Departmental policy to develop integrated multimodal projects in balance with community goals, plans, and values.

The Complete Intersections: A Guide to Reconstructing Intersections and Interchanges for Bicyclists and Pedestrians contains a primer on the factors to consider when designing intersections. It is published by the California Division of Traffic Operations.

401.2 Human Factors

(1) *The Driver.* An appreciation of driver performance is essential to proper highway design and operation. The suitability of a design rests as much on how safely and efficiently drivers are able to use the highway as on any other criterion.

Motorist's perception and reaction time set the standards for sight distance and length of transitions. The driver's ability to understand and interpret the movements and crossing

May 20, 2022

times of the other vehicle drivers, bicyclists, and pedestrians using the intersection is equally important when making decisions and their associated reactions. The designer needs to keep in mind the user's limitations and therefore design intersections so that they meet user expectation.

- (2) *The Bicyclist.* Bicyclist experience, skills and physical capabilities are factors in intersection design. Intersections are to be designed to help bicyclists understand how to traverse the intersection. Chapter 1000 provides intersection guidance for Class I and Class III bikeways that intersect the State highway system. The guidance in this chapter specifically relates to bicyclists that operate within intersections on the State highway system.
- (3) *The Pedestrian.* Understanding how pedestrians will use an intersection is critical because pedestrian volumes, their age ranges, physical ability, etc. all factor in to their startup time and the time it takes them to cross an intersection and thus, dictates how to design the intersection to avoid potential conflicts with bicyclists and motor vehicles. The guidance in this chapter specifically relates to pedestrian travel within intersections on the State highway system. See Topic 105, Pedestrian Facilities, Design Information Bulletin 82 - "Pedestrian Accessibility Guidelines for Highway Projects," the AASHTO Guide for the Planning, Design, and Operation of Pedestrian Facilities, and the California Manual on Uniform Traffic Control Devices (California MUTCD) for additional guidance.

401.3 Traffic Considerations

Good intersection design clearly indicates to bicyclists and motorists how to traverse the intersection (see Figure 403.6A). Designs that encourage merging traffic to yield to through bicycle and motor vehicle traffic are desirable.

The size, maneuverability, and other characteristics of bicycles and motorized vehicles (automobiles, trucks, transit vehicles, farm equipment, etc.) are all factors that influence the design of an intersection. The differences in operating characteristics between bicycles and motor vehicles should be considered early in design.

Table 401.3 compares vehicle characteristics to intersection design elements.

A design vehicle is a convenient means of representing a particular segment of the vehicle population. See Topic 404 for a further discussion of the uses of design vehicles.

Transit vehicles and how their stops interrelate with an intersection, pedestrian desired walking patterns and potential transfers to other transit facilities are another critical factor to understand when designing an intersection. Transit stops and their placement needs to take into account the required maintenance operations that will be needed and usually supplied by the Transit Operator.

401.4 The Physical Environment

In highly developed urban areas, where right of way is usually limited, the volume of vehicular traffic, pedestrians, and bicyclists may be large, street parking exists, and transit stops (for both buses and light rail) are available. All interact in a variety of movements that contribute to and add to the complexity of a State highway and can result in busy intersections.

Industrial development may require special attention to the movement of large trucks.

Rural areas where farming occurs may require special attention for specialized farm equipment. In addition, rural cities or town centers (rural main streets) also require special attention.

Rural intersections in farm areas with low traffic volumes may have special visibility problems or require shadowing of left-turn vehicles from high speed approach traffic.

Table 401.3

Vehicle Characteristics	Intersection Design Element Affected
Length	Length of storage lane
Width	Lane width
Height	Clearance to overhead signs and signals
Wheel base	Corner radius and width of turning lanes
Acceleration	Tapers and length of acceleration lane
Deceleration	Tapers and length of deceleration lane

There are many factors to be considered in the design of intersections, with the goal to achieve a functional, safe and efficient intersection for all users of the facility. The location and level of use by various modes will have an impact on intersection design, and therefore should be considered early in the design process. In addition to current levels of use, it is important to consider future travel patterns for vehicles, including trucks; pedestrian and bicycle demand and the future expansion of transit.

401.5 Intersection Type

Intersection types are characterized by their basic geometric configuration, and the form of intersection traffic control that is employed:

(1) Geometric Configurations

- (a) Crossing-Type Intersections - “Tee” and 4-legged intersections
- (b) Circular Intersections –roundabouts, traffic circles, rotaries; however, only roundabouts are acceptable for State highways.
- (c) Alternative Intersection Designs – various effective geometric alternatives to traditional designs that can reduce crashes and their severity, improve operations, reduce congestion and delay typically by reducing or altering the number of conflict points; these alternatives include geometric design features such as intersections with displaced left-turns or variations on U-turns. For more information on alternative intersection designs see FHWA’s Intersection Safety webpage: <https://safety.fhwa.dot.gov/intersection/>.

July 1, 2020

(2) *Intersection Control Strategies.* See California MUTCD and Traffic Operations Policy Directive (TOPD) Number 13-02, Intersection Control Evaluation for procedures and guidance on how to evaluate, compare and select from among the following intersection control strategies:

- (a) Two-Way Stop Controlled - for minor road traffic
- (b) All-Way Stop Control
- (c) Signal Control
- (d) Yield Control (Roundabout)

Historically, crossing-type intersections with signal or “STOP”-control have been used on the State highway system. However, other intersection types, given the appropriate circumstances may enhance intersection performance through fewer or less severe crashes and improve operations by reducing overall delay. Alternative intersection geometric designs should be considered and evaluated early in the project scoping, planning and decision-making stages, as they may be more efficient, economical and safer solutions than traditional designs. Alternative intersection designs can effectively balance the safety and mobility needs of the motor vehicle drivers, transit riders, bicyclists and pedestrians using the intersection.

401.6 Transit

Transit use may range from periodic buses, handled as part of the normal mix of vehicular traffic, to Bus Rapid Transit (BRT) or light rail facilities which can have a large impact on other users of the intersection. Consideration of these modes should be part of the early planning and design of intersections.

Topic 402 – Operational Features Affecting Design

402.1 Capacity

Adequate capacity to handle peak period traffic demands is a basic goal of intersection design.

- (1) *Unsignalized Intersections.* The “Highway Capacity Manual”, provides methodology for capacity analysis of unsignalized intersections controlled by “STOP” or “YIELD” signs. The assumption is made that major street traffic is not affected by the minor street movement. Unsignalized intersections generally become candidates for signalization when traffic backups begin to develop on the cross street or when gaps in traffic are insufficient for drivers to yield to crossing pedestrians. See the California MUTCD, for signal warrants. Changes to intersection controls must be coordinated with District Traffic Branch.
- (2) *Signalized Intersections.* See Topic 406 for analysis of simple signalized intersections, including ramps. The analysis of complex and alternative intersections should be referred to the District Traffic Branch; also see Traffic Operations Policy Directive (TOPD) Number 13-02.
- (3) *Roundabout Intersections.* See TOPD Number 13-02 for screening process and the Intersection Control Evaluation(ICE) Process Informational Guide for operational analysis methods and tools.

402.2 Collisions

(1) *General.* Intersections have a higher potential for conflict compared to other sections of the highway because travel is interrupted, traffic streams cross, and many types of turning movements occur.

The type of traffic control affects the type of collisions. Signalized intersections tend to have more rear end and same-direction sideswipes than intersections with “STOP”-control on minor legs. Roundabouts experience few angle or crossing collisions. Roundabouts reduce the frequency and severity of collisions, especially when compared to the performance of signalized intersections in high speed environments. Other alternative intersection types are configurations to consider for minimizing the number of conflict points.

(2) *Undesirable Geometric Features.*

- Inadequate approach sight distance.
- Inadequate corner sight distance.
- Steep grades.
- Five or more approaches.
- Presence of curves within intersections(unless at roundabouts).
- Inappropriately large curb radii.
- Long pedestrian crossing distances.
- Intersection Angle <75 degrees (see Topic 403).

402.3 On-Street Parking

On-street parking generally decreases through-traffic capacity, impedes traffic flow, and increases crash potential. Where the primary service of the arterial is the movement of vehicles, it may be desirable to prohibit on-street parking on State highways in urban and suburban expressways and rural arterial sections. However, within urban and suburban areas and in rural communities located on State highways, on-street parking should be considered in order to accommodate existing land uses. Where adequate off-street parking facilities are not available, the designer should consider on-street parking, so that the proposed highway improvement will be compatible with the land use. On-street parking as well as off-street parking needs to comply with DIB82. See AASHTO, A Policy on Geometric Design of Highways and Streets for additional guidance related to on-street parking.

July 1, 2020

402.4 Consider All Users

Intersections should accommodate all users of the facility, including vehicles, bicyclists, pedestrians and transit. Bicycles have all the rights and responsibilities as motorist per the California Vehicle Code, but should have separate consideration of their needs, even separate facilities if volumes warrant. Pedestrians should not be prohibited from crossing one or more legs of an intersection, unless no other safe alternative exists. Pedestrians can be prohibited from crossing one or more legs of an intersection if a reasonable alternate route exists and there is a demonstrated need to do so. All pedestrian facilities shall be ADA compliant as outlined in DIB 82. Transit needs should be determined early in the planning and design phase as their needs can have a large impact on the performance of an intersection. Transit stops in the vicinity of intersections should be evaluated for their effect on the safety and operation of the intersection(s) under study. See Topic 108 for additional information.

402.5 Speed-Change Areas

Speed-change areas for vehicles entering or leaving main streams of traffic are beneficial to the safety and efficiency of an intersection. Entering traffic merges most efficiently with through traffic when the merging angle is less than 15 degrees and when speed differentials are at a minimum.

Topic 403 – Principles of Channelization

403.1 Preference to Major Movements

The provision of direct free-flowing high-standard alignment to give preference to major movements is good channelization practice. This may require some degree of control of the minor movements such as stopping, funneling, or even eliminating them. These controlling measures should conform to natural paths of movement and should be introduced gradually to promote smooth and efficient operation.

403.2 Areas of Conflict

Large multilane undivided intersection areas are undesirable. The hazards of conflicting movements are magnified when motorists, bicyclists, and pedestrians are unable to anticipate movements of other users within these areas. Channelization reduces areas of conflict by separating or regulating traffic movements into definite paths of travel by the use of pavement markings or traffic islands.

Multilane undivided intersections, even with signalization, are more difficult for pedestrians to cross. Providing pedestrian refuge islands enable pedestrians to cross fewer lanes at a time.

See Index 403.7 for traffic island guidance when used as pedestrian refuge. Curb extensions shorten crossing distance and increase visibility. See Index 303.4 for curb extensions.

403.3 Angle of Intersection

A right angle (90°) intersection provides the most favorable conditions for intersecting and turning traffic movements. Specifically, a right angle provides:

- The shortest crossing distance for motor vehicles, bicycles, and pedestrians.
- Sight lines which optimize corner sight distance and the ability of motorists to judge the relative position and speed of approach traffic.
- Intersection geometry that can reduce vehicle turning speeds so collisions are more easily avoided and the severity of collisions are minimized.
- Intersection geometry that sends a message to turning bicyclists and motorists that they are making a turning movement and should yield as appropriate to through traffic on the roadway they are leaving, to traffic on the receiving roadway, and to pedestrians crossing the intersection.

Minor deviations from right angles are generally acceptable provided that the potentially detrimental impact on visibility and turning movements for large trucks (see Topic 404) can be mitigated. However, large deviations from right angles may decrease visibility, hamper certain turning operations, and will increase the size of the intersection and therefore crossing distances for bicyclists and pedestrians, may encourage high speed turns, and may reduce yielding by turning traffic. When a right angle cannot be provided due to physical constraints, the interior angle should be designed as close to 90 degrees as is practical, but should not be less than 75 degrees. Mitigation should be considered for the affected intersection design features. (See Figure 403.3A). A 75 degree angle does not unreasonably increase the crossing distance or generally decrease visibility. Class II bikeway crossings at railroads follow similar guidance to Class I bikeway crossings at railroads, see Index 1003.5(3), and Figure 403.3B.

A characteristic of skewed intersection angles is that they result in larger intersections.

When existing intersection angles are less than 75 degrees, the following retrofit improvement strategies should be considered:

- Realign the subordinate intersection legs if the new alignment and intersection location(s) can be designed without introducing new geometric or operational deficiencies.
- Provide acceleration lanes for difficult turning movements due to radius or limited visibility.
- Restrict problematic turning movements; e.g. for minor road left turns with potentially limited visibility.
- Provide refuge areas for pedestrians at very long crossings.

For additional guidance on the above and other improvement strategies, consult with the District Design Liaison.

Particular attention should be given to skewed angles on curved alignment with regards to sight distance and visibility. Crossroads skewed to the left have more restricted visibility for drivers of vans and trucks than crossroads skewed to the right. In addition, severely skewed intersection angles, coupled with steep downgrades (generally over 4 percent) can increase the potential for high centered vehicles to overturn where the vehicle is on a downgrade and must make a turn greater than 90 degrees onto a crossroad. These factors should be considered in the design of skewed intersections.

July 1, 2020

403.4 Points of Conflict

Channelization separates and clearly defines points of conflict within the intersection. Bicyclists, pedestrians and motorists should be exposed to only one conflict or confronted with one decision at a time.

Speed-change areas for diverging traffic should provide adequate length clear of the through lanes to permit vehicles to decelerate after leaving the through lanes.

See AASHTO, A Policy on Geometric Design of Highways and Streets for additional guidance on speed-change lanes.

Figure 403.3A

Angle of Intersection (Minor Leg Skewed to the Right)

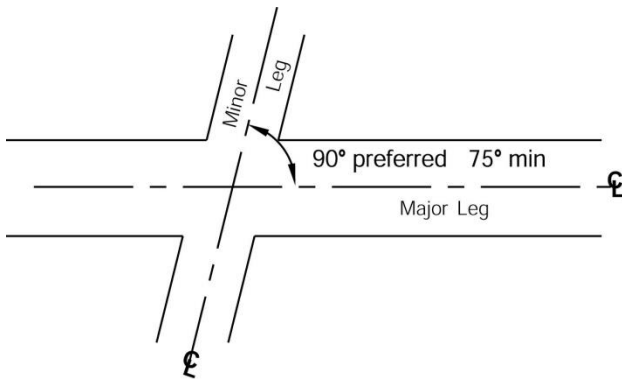
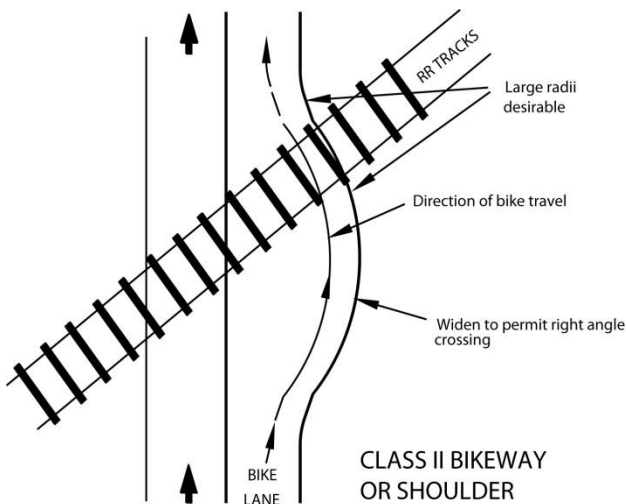

Figure 403.3.B

Class II Bikeway Crossing Railroad



403.5 (Currently Not In Use)

403.6 Turning Traffic

A separate turning lane removes turning movements from the intersection area. Abrupt changes in alignment or sight distance should be avoided, particularly where traffic turns into a separate turning lane from a high-standard through facility.

For wide medians, consider the use of offset left-turn lanes at both signalized and unsignalized intersections. Opposing left-turn lanes are offset or shifted as far to the left as practical by reducing the width of separation immediately before the intersection. Rather than aligning the left-turn lane exactly parallel with and adjacent to the through lane, the offset left-turn lane is separated from the adjacent through lane. Offset left-turn lanes provide improved visibility of opposing through traffic. For further guidance on offset left-turn lanes, see AASHTO, A Policy on Geometric Design of Highways and Streets.

(1) *Treatment of Intersections with Right-Turn-Only Lanes.* Most motor vehicle/bicycle collisions occur at intersections. For this reason, intersection design should be accomplished in a manner that will minimize confusion by motorists and bicyclists, eliminate ambiguity and induce all road users to operate in accordance with the statutory rules of the road in the California Vehicle Code. Right-turn-only lanes should be designed to meet user expectations and reduce conflicts between vehicles and bicyclists.

Figure 403.6A illustrates a typical at-grade intersection of multilane streets without right-turn-only lanes. Bike lanes or shoulders are included on all approaches. Some common movements of motor vehicles and bicycles are shown. A prevalent crash type is between straight-through bicyclists and right-turning motorists, who do not yield to through bicyclists.

Optional right-turn lanes should not be used in combination with right-turn-only lanes on roads where bicycle travel is permitted. The use of optional right-turn lanes in combination with right-turn-only lanes is not recommended in any case where a Class II bike lane is present. This may increase the need for dual or triple right-turn-only lanes, which have

July 1, 2020

Figure 403.6A

Typical Bicycle and Motor Vehicle Movements at Intersections of Multilane Streets without Right-Turn-Only Lanes

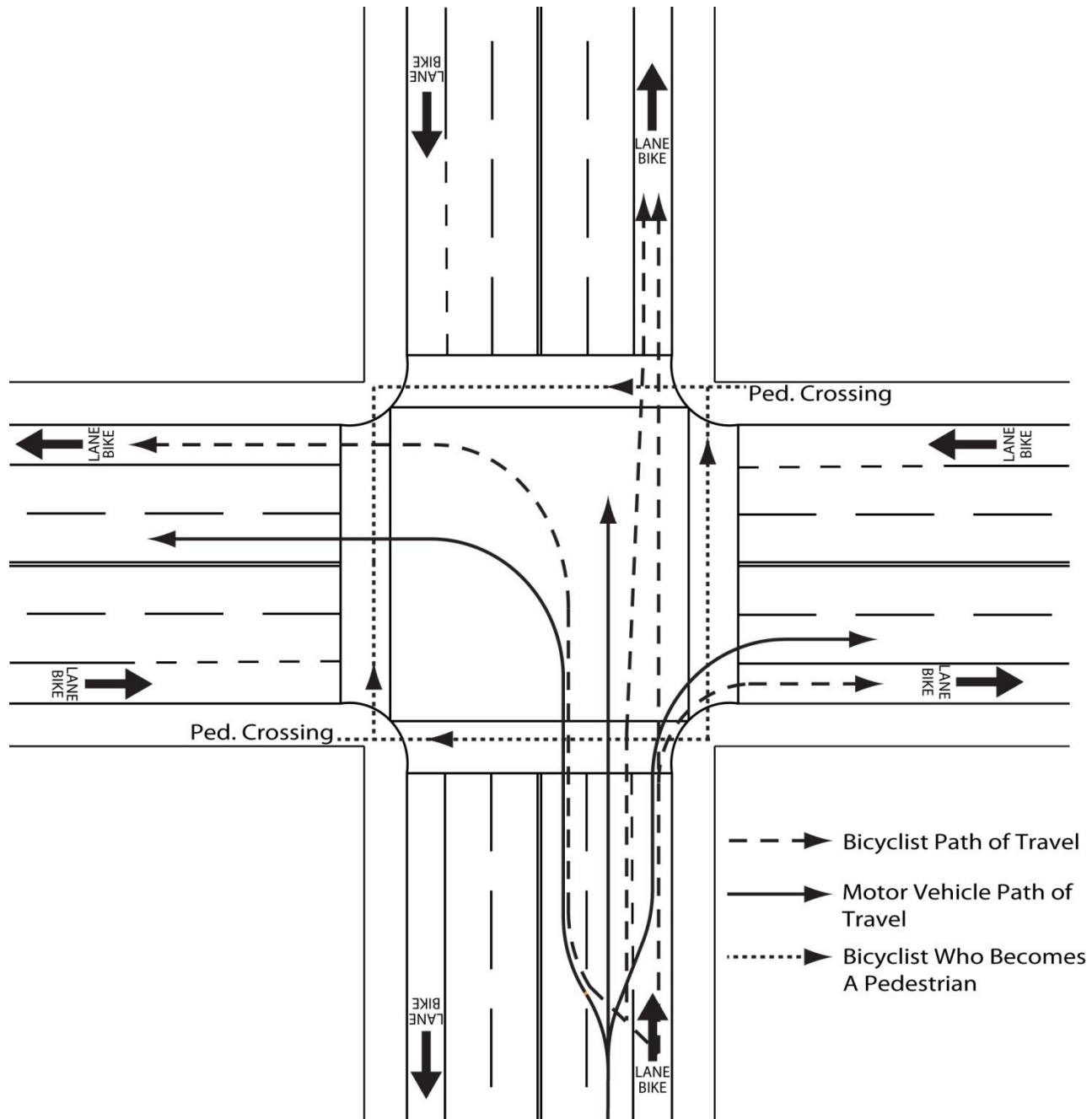

NOTE:

Only one direction is shown for clarity.

challenges with visibility between turning vehicles and pedestrians. Multiple right-turn-only lanes should not be free right-turns when there is a pedestrian crossing. If there is a pedestrian crossing on the receiving leg of multiple right-turn-only lanes, the intersection should be controlled by a pedestrian signal head, or geometrically designed such that pedestrians cross only one turning lane at a time.

Locations with right-turn-only lanes should provide a minimum 4-foot width for bicycle use between the right-turn and through lane when bikes are permitted, except where posted speed is greater than 40 miles per hour, the minimum width should be 6 feet. Configurations that create a weaving area without defined lanes should not be used.

For signing and delineation of bicycle lanes at intersections, consult District Traffic Operations.

Figure 403.6B depicts an intersection with a left-turn-only bicycle lane, which should be considered when bicycle left-turns are common. A left-turn-only bicycle lane may be considered at any intersection and should always be considered as a tool to provide mobility for bicyclists. Signing and delineation options for bicycle left-turn-only lanes are shown in the California MUTCD.

- (2) *Design of Intersections at Interchanges.* The design of at-grade intersections at interchanges should be accomplished in a manner that will minimize confusion of motorists, bicyclists, and pedestrians. Higher speed, uncontrolled entries and exits from freeway ramps should not be used at the intersection of the ramps with the local road. The smallest curb return radius should be used that accommodates the design vehicle. Intersections with interior angles close to 90 degrees reduce speeds at conflict points between motorists, bicyclists, and pedestrians. The intersection skew guidance in Index 403.3 applies to all ramp termini at the local road.

403.7 Refuge Areas

Traffic islands should be used to provide refuge areas for bicyclists and pedestrians. See Index 405.4 for further guidance.

403.8 Prohibited Turns

Traffic islands may be used to direct bicycle and motorized vehicle traffic streams in desired directions and prevent undesirable movements. Care should be taken so that islands used for this purpose accommodate convenient and safe pedestrian and bicycle crossings, drainage, and striping options. See Topic 303.

403.9 Effective Signal Control

At intersections with complex turning movements, channelization is required for effective signal control. Channelization permits the sorting of approaching bicycles and motorized vehicles which may move through the intersection during separate signal phases. Pedestrians may also have their own signal phase. This requirement is of particular importance when traffic-actuated signal controls are employed.

July 1, 2020

Figure 403.6B

Bicycle Left-Turn-Only Lane

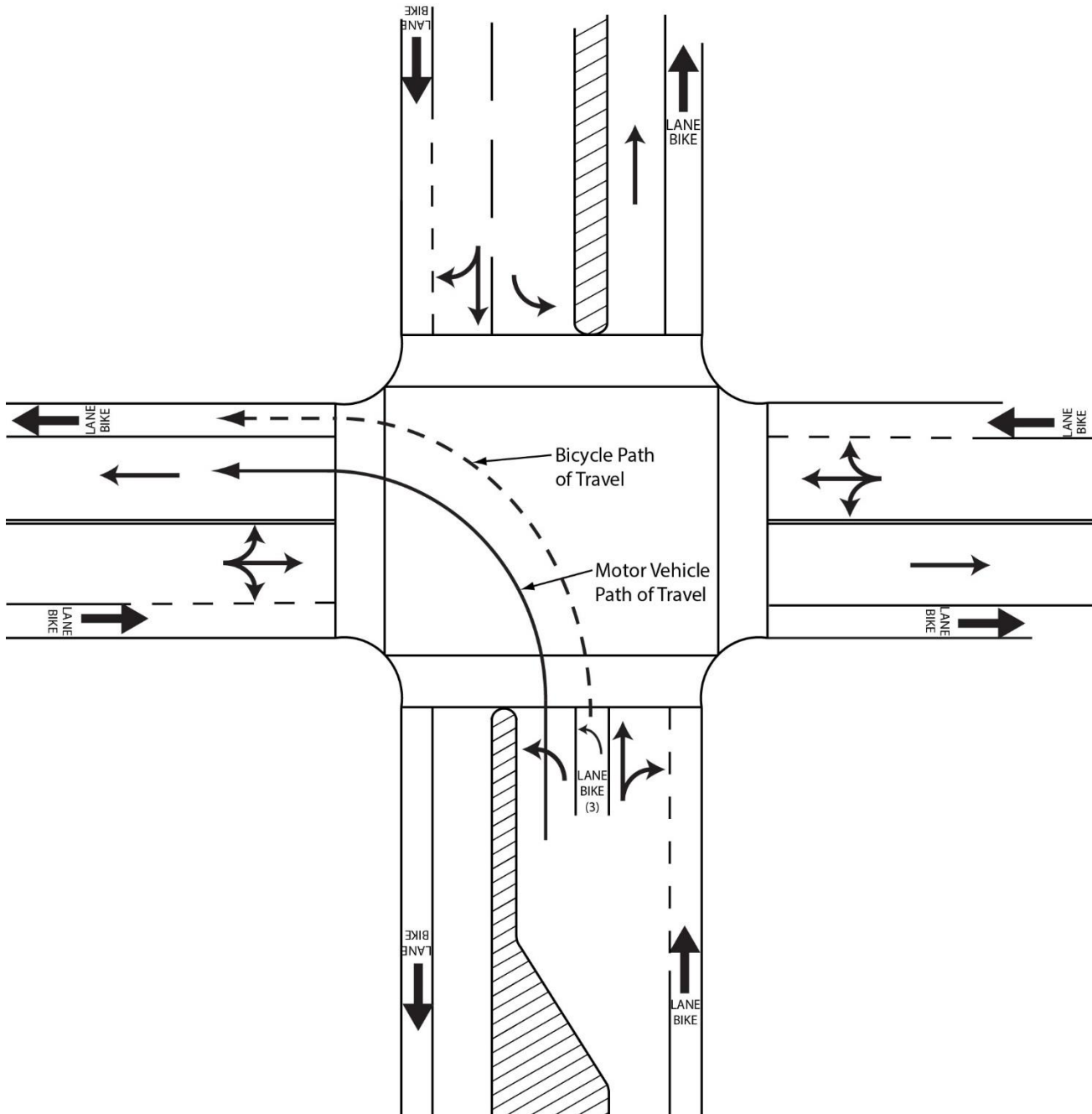

NOTES:

- (1) For bicycle lane markings, see the California MUTCD.
- (2) Bicycle detectors are necessary for signalized intersections.
- (3) Left-turn bicycle lane should have receiving bike lane or shoulder.

The California MUTCD has warrants for the placement of signals to control vehicular, bicycle and pedestrian traffic. Pedestrian activated devices, signals or beacons are not required, but must be evaluated where directional, multilane, pedestrian crossings occur. These locations may include:

- Mid-block street crossings;
- Channelized turn lanes;
- Ramp entries and exits; and
- Roundabouts.

The evaluation, selection, programming and use of a chosen device should be done with guidance from District Traffic Operations.

403.10 Installation of Traffic Control Devices

Channelization may provide locations for the installation of essential traffic control devices, such as “STOP” and directional signs. See Index 405.4 for information about the design of traffic islands.

403.11 Summary

- Give preference to the major move(s).
- Reduce areas of conflict.
- Reduce the duration of conflicts.
- Cross traffic at right angles or skew no more than 75 degrees. (90 degrees preferred.)
- Separate points of conflict.
- Provide speed-change areas and separate turning lanes where appropriate.
- Provide adequate width to shadow turning traffic.
- Restrict undesirable moves with traffic islands.
- Coordinate channelization with effective signal control.
- Install signs in traffic islands when necessary but avoid building conflicts one or more modes of travel.
- Consider all users.

403.12 Other Considerations

- An advantage of curbed islands is they can serve as pedestrian refuge. Where curbing is appropriate, consideration should be given to mountable curbs. See Topic 303 for more guidance.
- Avoid complex intersections that present multiple choices of movement to the motorist and bicyclist.
- Traffic safety should be considered. Collision records provide a valuable guide to the type of channelization needed.

May 20, 2022

Topic 404 – Design Vehicles

404.1 General

Any vehicle, whether car, bus, truck, or recreational vehicle, while turning a curve, covers a wider path than the width of the vehicle. The outer front tire can generally follow a circular curve, but the inner rear tire will swing in toward the center of the curve.

Some terminology is vital to understanding the engineering concepts related to design vehicles. See Index 62.4 Interchanges and Intersection at Grade for terminology.

404.2 Design Considerations

It may not be necessary to provide for design vehicle turning movements at all intersections along the State route if the design vehicle's route is restricted or it is not expected to use the cross street frequently. Discuss with Traffic Operations and the local agency before a turning movement is not provided. The goal is to minimize possible conflicts between vehicles, bicycles, pedestrians, and other users of the roadway, while providing the minimum curb radii appropriate for the given situation.

Both the tracking width and swept width should be considered in the design of roadways for use of the roadway by design vehicles.

Tracking width lines delineate the path of the vehicle tires as the vehicle moves through the turn.

Swept width lines delineate the path of the vehicle body as the vehicle moves through the turn and will therefore always exceed the tracking width. The following list of criteria is to be used to determine whether the roadway can accommodate the design vehicle.

(1) *Traveled way.*

(a) To accommodate turn movements (e.g., at intersections, driveways, alleys, etc.), the travel way width and intersection design should be such that tracking width and swept width lines for the design vehicle do not cross into any portion of the lane for opposing traffic. Encroachment into the shoulder and bike lane is permitted.

(b) Along the portion of roadway where there are no turning options, vehicles are required to stay within the lane lines. **The tracking and swept widths lines for the design vehicle shall stay within the lane as defined in Index 301.1 and Table 504.3.** This includes no encroachment into Class II bike lanes.

(2) *Shoulders.* Both tracking width and swept width lines may encroach onto paved shoulders to accommodate turning. For design projects where the tracking width lines are shown to encroach onto paved shoulders, the shoulder pavement structure should be engineered to sustain the weight of the design vehicle. See Index 613 for general traffic loading considerations and Index 626 for tied rigid shoulder guidance. At corners where no sidewalks are provided and pedestrians are using the shoulder, a paved refuge area may be provided outside the swept width of turning vehicle.

(3) *Curbs and Gutters.* Tires may not mount curbs. If curb and gutter are present and any portion of the gutter pan is likewise encroached, the gutter pan must be engineered to match the adjacent shoulder pavement structure. See Index 613.4(2)(h) for gutter pan design guidance.

- (4) *Edge of Pavement.* To accommodate a turn, the swept width lines may cross the edge of pavement provided there are no obstructions. The tracking width lines must remain on the pavement structure, including the shoulder, provided that the shoulder is designed to support vehicular traffic. If truck volumes are high, consideration of a wider shoulder is encouraged in order to preserve the pavement edge.
- (5) *Bicycle Lanes.* Where bicycle lanes are considered, the design guidance noted above applies. Vehicles are permitted to cross a bicycle lane to initiate or complete a turning movement or for emergency parking on the shoulder. See the California MUTCD for Class II bike lane markings.
- To accommodate turn movements (e.g., intersections, driveways, alleys, etc. are present), both tracking width and swept width lines may cross the broken white painted bicycle lane striping in advance of the right-turn, entering the bicycle lane when clear to do so.
- (6) *Sidewalks.* Tracking width and swept width lines must not encroach onto sidewalks or pedestrian refuge areas, without exception.
- (7) *Obstacles.* Swept width lines may not encroach upon obstacles including, but not limited to, curbs, islands, sign structures, traffic delineators/channelizers, traffic signals, lighting poles, guardrails, trees, cut slopes, and rock outcrops.
- (8) *Appurtenances.* Swept width lines do not include side mirrors or other appurtenances allowed by the California Vehicle Code, thus, accommodation to non-motorized users of the facility and appurtenances should be considered.

If both the tracking width and swept width lines meet the design guidance listed above, then the geometry is adequate for that design vehicle. Consideration should be given to pedestrian crossing distance, motor vehicle speeds, truck volumes, alignment, bicycle lane width, sight distance, and the presence of on-street parking.

Note that the STAA Design Vehicle has a template with a 56-foot (minimum) and a 67-foot (longer) radius and the California Legal Design Vehicle has a template with 50-foot (minimum) and 60-foot (longer) radii. These templates are shown in Figures 404.5A through 404.5D. The longer radius templates are more conservative. The longer radius templates develop less swept width and leave a margin of error for the truck driver. The longer radius templates should be used for conditions where the vehicle may not be required to stop before entering the intersection.

The minimum radius template can be used if the longer radius template does not clear all obstacles. The minimum radius templates demonstrate the tightest turn that the vehicles can navigate, assuming a speed of less than 10 miles per hour.

For offtracking lane width requirements on freeway ramps, see Topic 504.

The Caltrans Truck Network Maps should be consulted for the appropriate design vehicle. See the link at <https://dot.ca.gov/programs/traffic-operations/legal-truck-access/truck-network-map>.

404.3 Design Tools

District Truck Managers should be consulted early in the project to ensure compliance with the design vehicle guidance contained in Topic 404. Consult local agencies to verify the location of local truck routes. Essentially, two options are available – templates or computer software.

July 1, 2020

- The turning templates in Figures 404.5A through G are a design aid for determining the swept width and/or tracking width of large vehicles as they maneuver through a turn. The templates can be used as overlays to evaluate the adequacy of the geometric layout of a curve or intersection when reproduced on clear film and scaled to match the highway drawings. These templates assume a vehicle speed of less than 10 miles per hour.
- Computer software such as AutoTURN or AutoTrak can draw the swept width and/or tracking width along any design curve within a CADD drawing program such as MicroStation or AutoCAD. Dimensions taken from the vehicle diagrams in Figures 404.5A through G may be inputted into the computer program by creating a custom vehicle if the vehicle is not already included in the software library. The software can also create a vehicle turn template that conforms to any degree curve desired.

404.4 Design Vehicles and Related Definitions

(1) *The Surface Transportation Assistance Act of 1982 (STAA).*

- (a) STAA Routes. STAA allows certain longer trucks called STAA trucks to operate on the National Network. After STAA was enacted, the Department evaluated State routes for STAA truck access and created Terminal Access and Service Access routes which, together with the National Network, are called the STAA Network. Terminal Access routes allow STAA access to terminals and facilities. Service Access routes allow STAA trucks one-mile access off the National Network, but only at identified exits and only for designated services. Service Access routes are primarily local roads. A “Truck Route Map,” indicating the National Network routes and the Terminal Access routes is posted on the Department’s Office of Commercial Vehicle Operations website and is also available in printed form.
- (b) STAA Design Vehicle. The STAA design vehicle is a truck tractor-semitrailer combination with a 48-foot semitrailer, a 43-foot kingpin-to-rear-axle (KPR) distance, an 8.5-foot body and axle width, and a 23-foot truck tractor wheelbase. Note, a truck tractor is a non-load-carrying vehicle. There is also a STAA double (truck tractor-semitrailer-trailer); however, the double is not used as the design vehicle due to its shorter turning radius. The STAA Design Vehicle is shown in Figures 404.5A and B.

The STAA Design Vehicle in Figures 404.5A or B should be used on the National Network, Terminal Access, California Legal, and Advisory routes.

- (c) STAA Vehicle – 53-Footer. Another category of vehicle allowed only on STAA routes has a maximum 53-foot trailer, a maximum 40-foot KPR for two or more axles, a maximum 38-foot KPR for a single axle, and unlimited overall length. This vehicle is not to be used as the design vehicle as it is not the worst case for offtracking due to its shorter KPR. The STAA Design Vehicle should be used instead.

(2) *California Legal.*

- (a) California Legal Routes. Virtually all State routes off the STAA Network are California Legal routes. There are two types of California Legal routes, the regular California Legal routes and the KPR Advisory Routes. Advisory routes have signs posted that state the maximum KPR length that the route can accommodate without the vehicle offtracking outside the lane. KPR advisories range from 30 feet to 38 feet, in 2-foot increments. California Legal vehicles are allowed to use both types of California Legal routes. California Legal vehicles can also use the STAA Network. However, STAA trucks are not allowed on any California Legal routes. The Truck Route Map indicating the California Legal routes is posted on the Department’s Office of Commercial Vehicle Operations website.

- (b) California Legal Design Vehicle. The California Legal vehicle is a truck tractor-semitrailer with the following dimensions: the maximum overall length is 65 feet; the maximum KPRA distance is 40 feet for semitrailers with two or more axles, and 38 feet for semitrailers with a single axle; the maximum width is 8.5 feet. There are also two categories of California Legal doubles (truck tractor-semitrailer-trailer); however, the doubles are not used as the design vehicle due to their shorter turning radii. The California Legal Design Vehicle is shown in Figures 404.5C and D.

The California Legal Design Vehicle in Figures 404.5C and D should only be used when the STAA design vehicle is not feasible and with concurrence from the District Truck Manager.

(3) *40-Foot Bus.*

- (a) 40-Foot Bus Routes. All single-unit vehicles, including buses and motor trucks up to 40 feet in length, are allowed on virtually every route in California.
- (b) 40-Foot Bus Design Vehicle. The 40-Foot Bus Design Vehicle shown in Figure 404.5E is an AASHTO standard. Its 25-foot wheelbase and 40-foot length are typical of city transit buses and some intercity buses. At intersections where truck volumes are light or where the predominate truck traffic consists of mostly 3-axle units, the 40-foot bus may be used. Its wheel path sweeps a greater width than 3-axle delivery trucks, as well as smaller buses such as school buses.

(4) *45-Foot Bus & Motorhome.*

- (a) 45-Foot Bus & Motorhome Routes. The “45-foot bus and motorhome” refers to bus and motorhomes over 40 feet in length, up to and including 45 feet in length. These longer buses and motorhomes are allowed in California, but only on certain routes.

The 45-foot tour bus became legal on the National Network in 1991 and later allowed on some State routes in 1995. The 45-foot motorhome became legal in California in 2001, but only on those routes where the 45-foot bus was already allowed. A Bus and Motorhome Map indicating where these longer buses and motorhomes are allowed and where they are not allowed is posted on the Department’s Office of Commercial Vehicle Operations website.

- (b) 45-Foot Bus and Motorhome Design Vehicle. The 45-Foot Bus & Motorhome Design Vehicle shown in Figure 404.5F is used by Caltrans for the longest allowable bus and motorhome. Its wheelbase is 28.5 feet. It is also similar to the AASHTO standard 45-foot bus. Typically this should be the smallest design vehicle used on a State highway. It may be used where the State highway intersects local streets without commercial or industrial traffic.

The 45-Foot Bus and Motorhome Design Vehicle shown in Figure 404.5F should be used in the design of all interchanges and intersections on all green routes indicated on the Bus and Motorhome Map for both new construction and rehabilitation projects. Check also the longer standard design vehicles on these routes as required – the STAA Design Vehicle and the California Legal Design Vehicle in Indexes 404.4(1) and (2).

July 1, 2020

(5) *60-Foot Articulated Bus.*

(a) 60-Foot Articulated Bus Routes. The articulated bus is allowed a length of up to 60 feet per CVC 35400(b)(3)(A). This bus is used primarily by local transit agencies for public transportation. There is no master listing of such routes. Local transit agencies should be contacted to determine possible routes within the proposed project.

(b) 60-Foot Articulated Bus Design Vehicle. The 60-Foot Articulated Bus Design Vehicle shown in Figure 404.5G is an AASHTO standard. The routes served by these buses should be designed to accommodate the 60-Foot Articulated Bus Design Vehicle.

404.5 Turning Templates & Vehicle Diagrams

Figures 404.5A through G are computer-generated turning templates at an approximate scale of 1"=50' and their associated vehicle diagrams for the design vehicles described in Index 404.3. The radius of the template is measured to the outside front wheel path at the beginning of the curve. Figures 404.5A through G contain the terms defined as follows:

(1) *Tractor Width* - Width of tractor body.

(2) *Trailer Width* - Width of semitrailer body.

(3) *Tractor Track* - Tractor axle width, measured from outside face of tires.

(4) *Trailer Track* - Semitrailer axle width, measured from outside face of tires.

Figure 404.5A

STAA Design Vehicle 56-Foot Radius

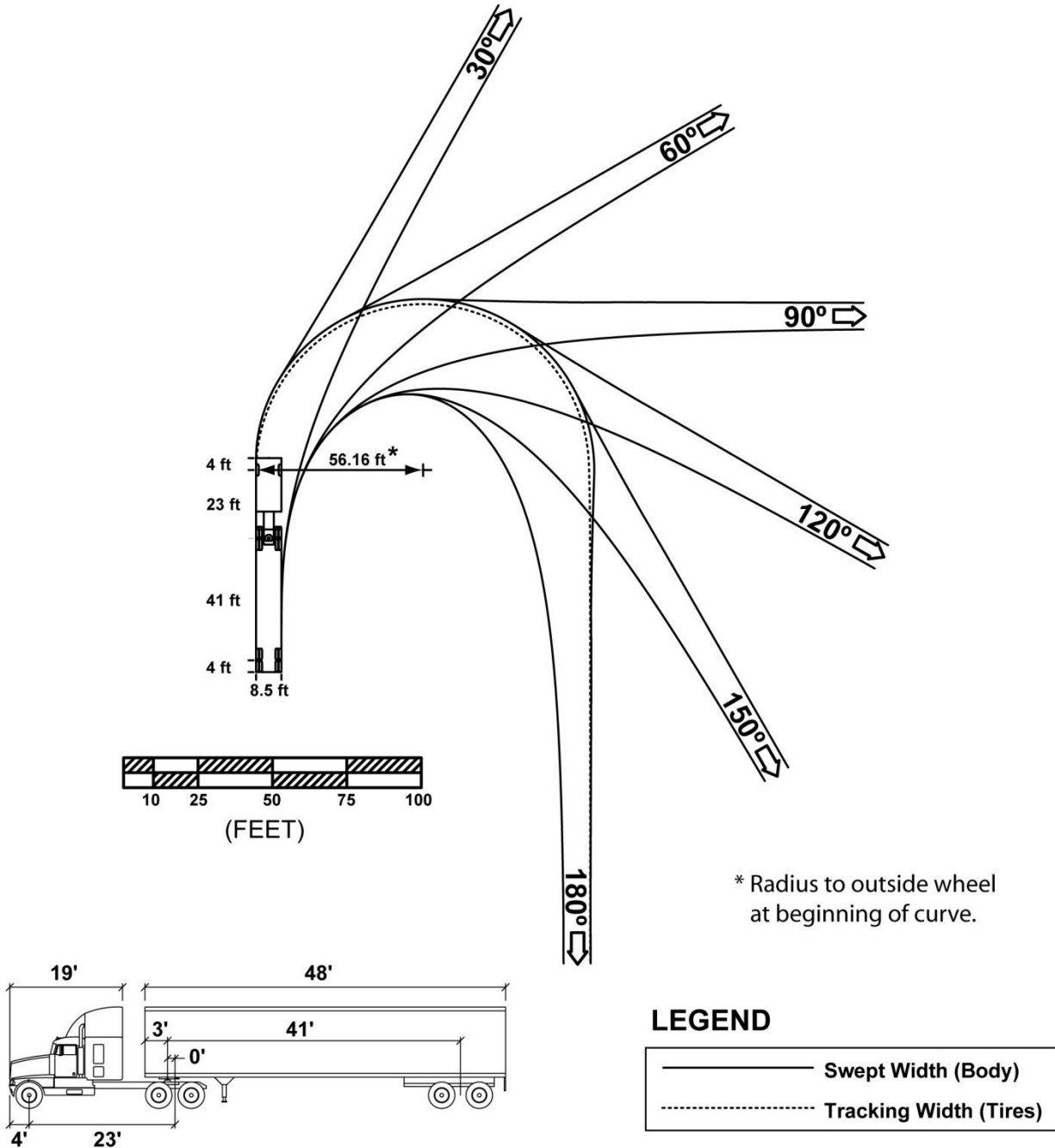

STAA - STANDARD

Tractor Width	: 8.5'	Lock to Lock Time	: 6 seconds
Trailer Width	: 8.5'	Steering Lock Angle	: 26.3 degrees
Tractor Track	: 8.5'	Articulating Angle	: 70 degrees
Trailer Track	: 8.5'		

Note: For definitions, see Indexes 404.1 and 404.5.

July 1, 2020

Figure 404.5B

STAA Design Vehicle 67-Foot Radius

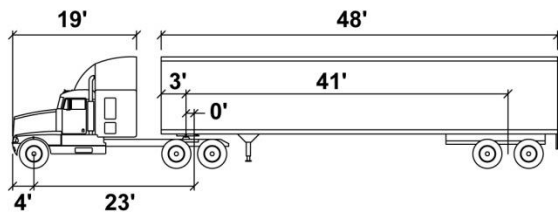
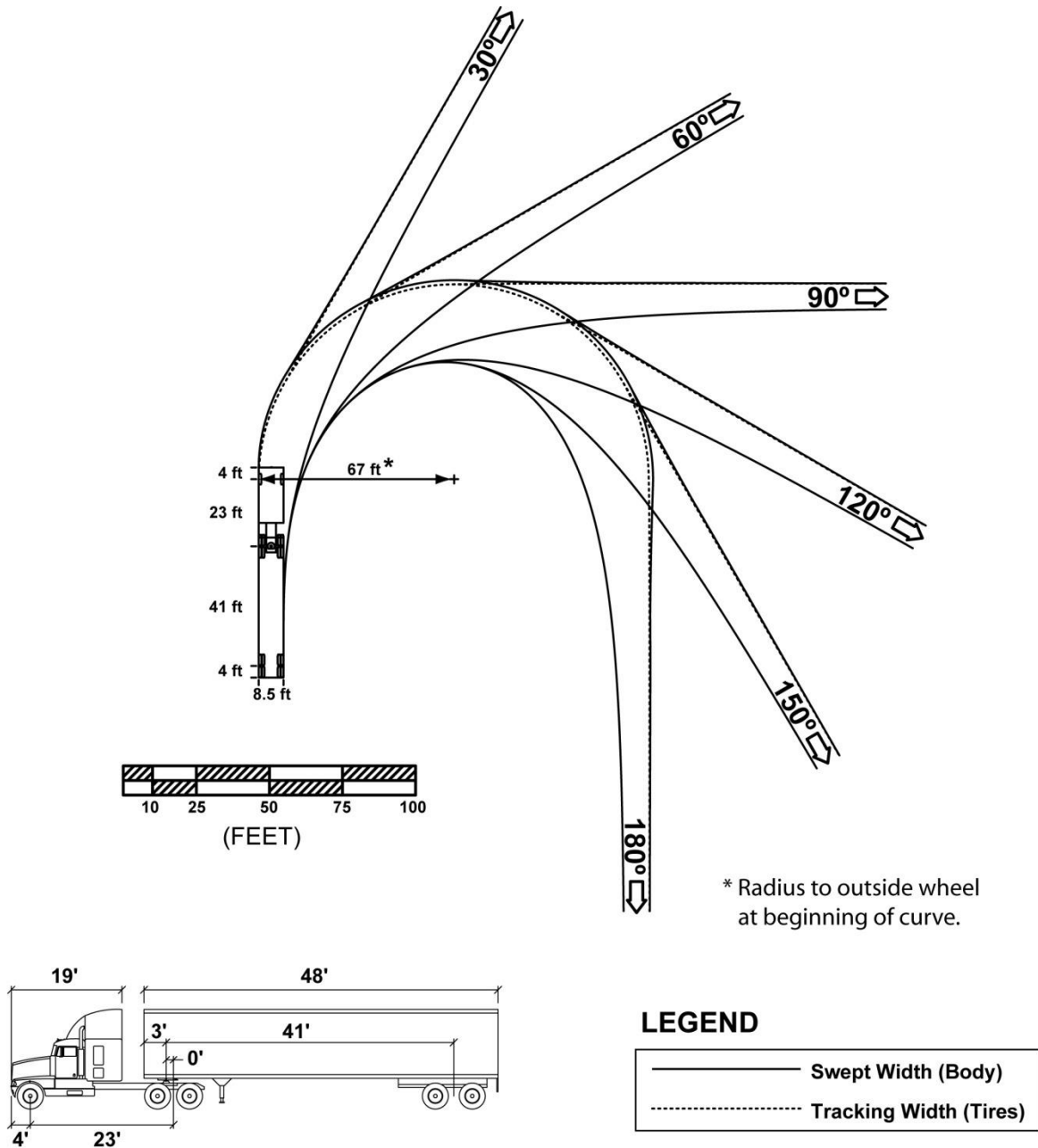

STAA - STANDARD

- Tractor Width : 8.5'
- Trailer Width : 8.5'
- Tractor Track : 8.5'
- Trailer Track : 8.5'

- Lock to Lock Time : 6 seconds
- Steering Lock Angle : 26.3 degrees
- Articulating Angle : 70 degrees

Note: For definitions, see Indexes 404.1 and 404.5.

Figure 404.5C

California Legal Design Vehicle 50-Foot Radius

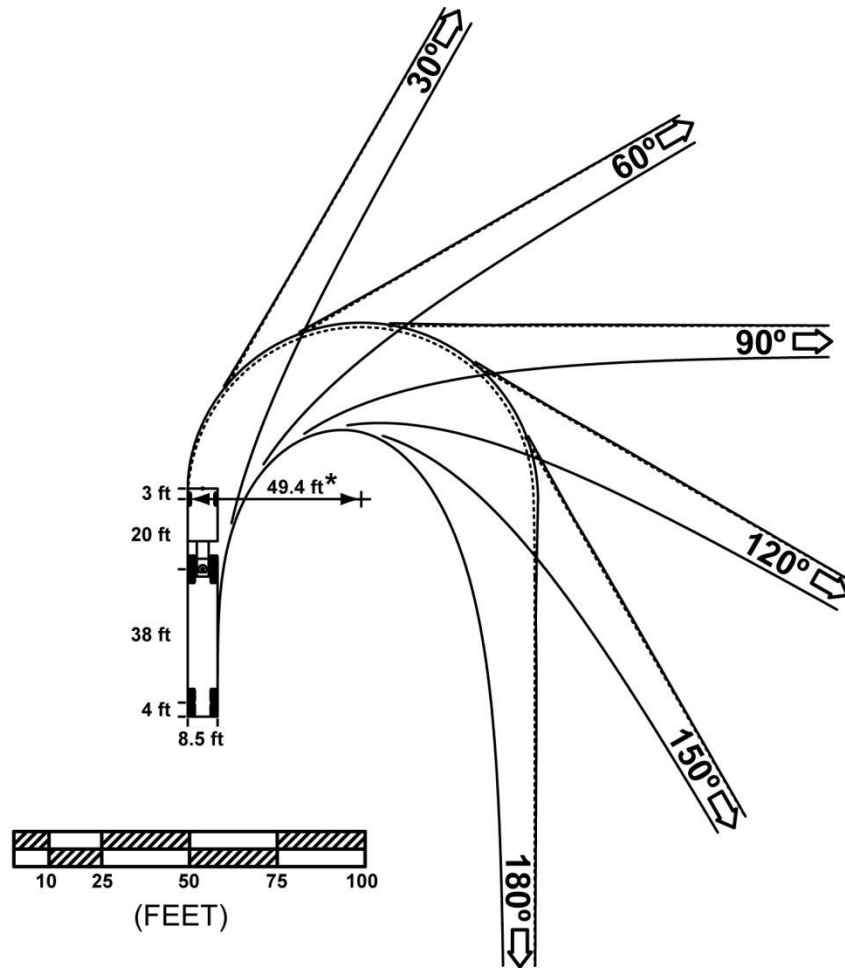

* Radius to outside wheel at beginning of curve.

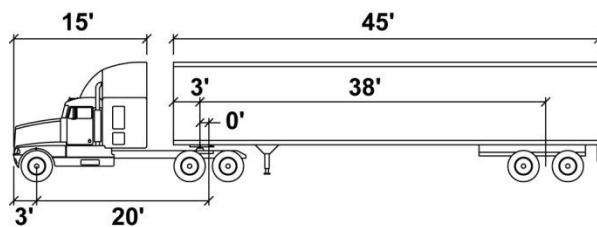

LEGEND

	Swept Width (Body)
	Tracking Width (Tires)

CA LEGAL - 65 FT

Tractor Width	: 8.5'	Lock to Lock Time	: 6 seconds
Trailer Width	: 8.5'	Steering Lock Angle	: 26.3 degrees
Tractor Track	: 8.5'	Articulating Angle	: 70 degrees
Trailer Track	: 8.5'		

Note: For definitions, see Indexes 404.1 and 404.5.

July 1, 2020

Figure 404.5D

California Legal Design Vehicle 60-Foot Radius

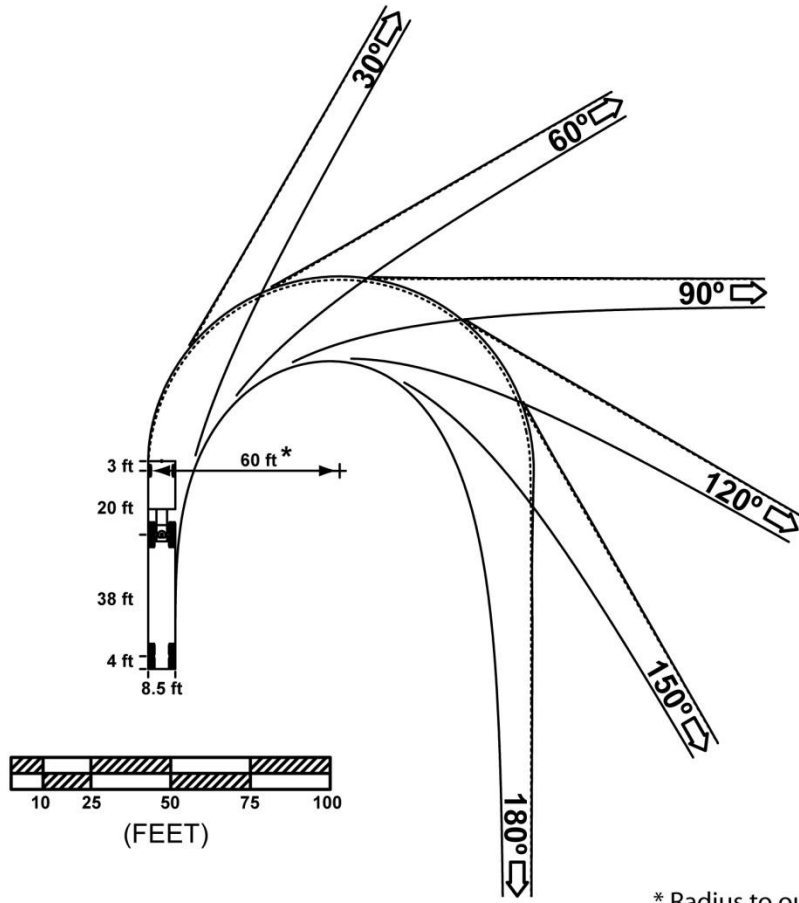

* Radius to outside wheel at beginning of curve.

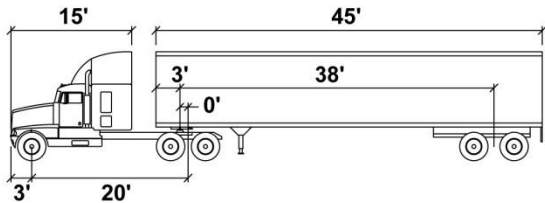

LEGEND

	Swept Width (Body)
	Tracking Width (Tires)

CA LEGAL - 65 FT

Tractor Width	: 8.5'	Lock to Lock Time	: 6 seconds
Trailer Width	: 8.5'	Steering Lock Angle	: 26.3 degrees
Tractor Track	: 8.5'	Articulating Angle	: 70 degrees
Trailer Track	: 8.5'		

Note: For definitions, see Indexes 404.1 and 404.5.

Figure 404.5E

40-Foot Bus Design Vehicle

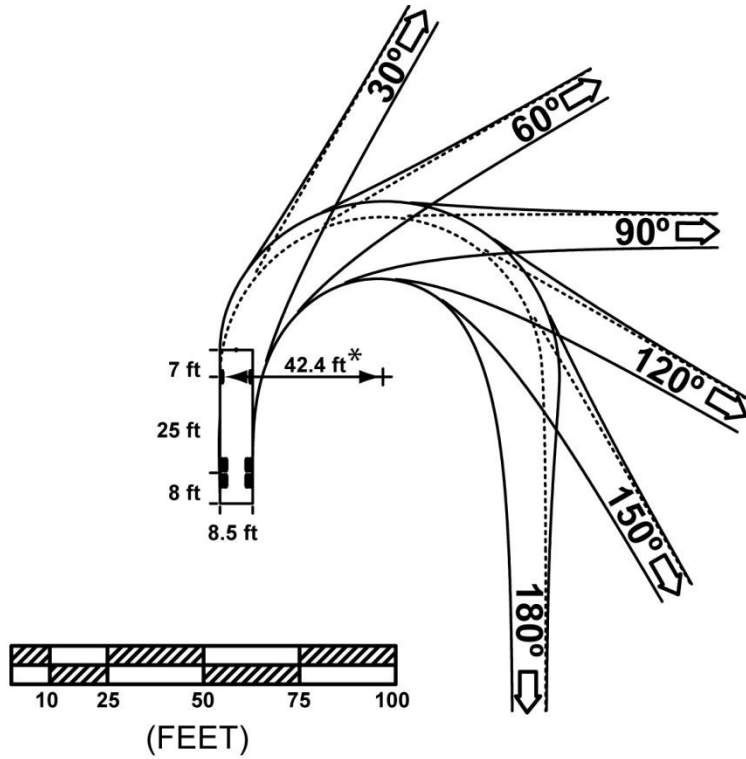

* Radius to outside wheel at beginning of curve.

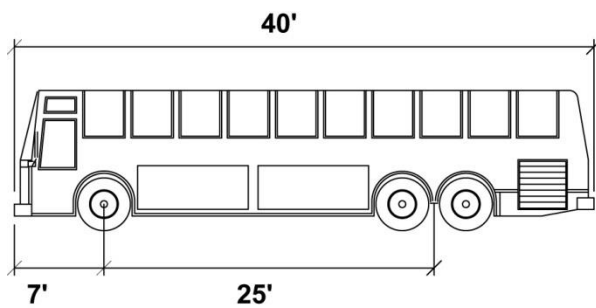

LEGEND

	Swept Width (Body)
	Tracking Width (Tires)

40' BUS

- Width : 8.5'
- Track : 8.5'
- Lock to Lock Time : 6 seconds
- Steering Lock Angle: 41.0 degrees

Note: For definitions, see Indexes 404.1 and 404.5.

July 1, 2020

Figure 404.5F

45-Foot Bus & Motorhome Design Vehicle

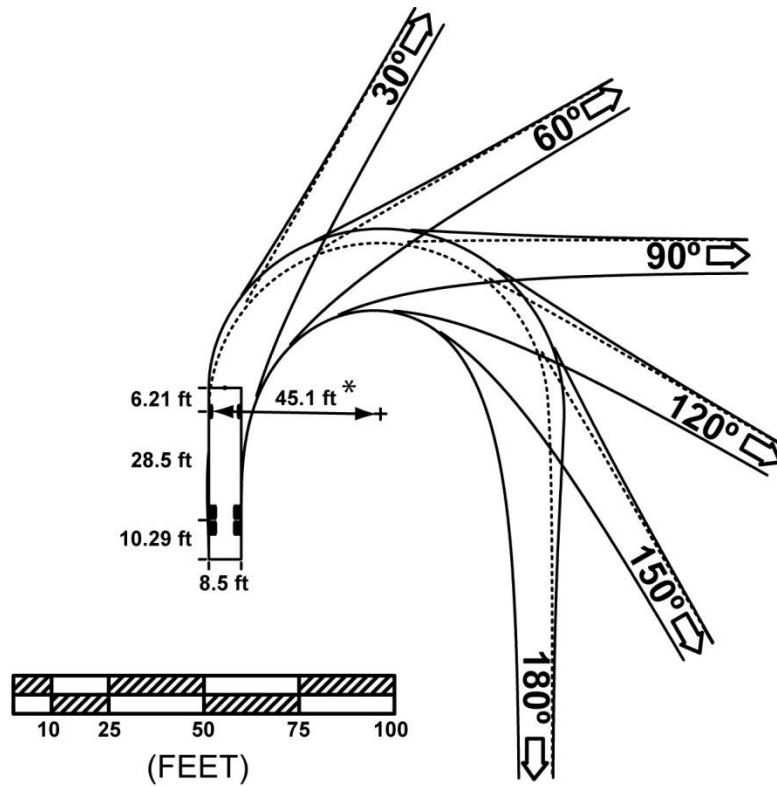

* Radius to outside wheel at beginning of curve.

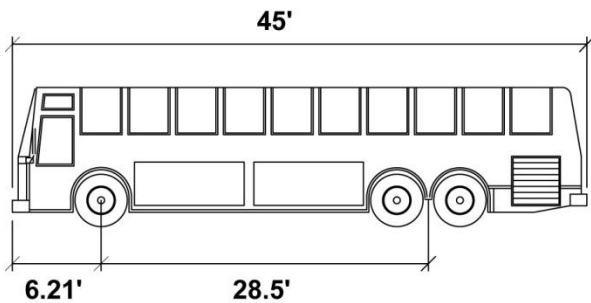

LEGEND

	Swept Width (Body)
	Tracking Width (Tires)

45' BUS

- Width : 8.5'
- Track : 8.5'
- Lock to Lock Time : 6 seconds
- Steering Lock Angle: 44.3 degrees

Note: For definitions, see Indexes 404.1, and 404.5.

Figure 404.5G

60-Foot Articulated Bus Design Vehicle

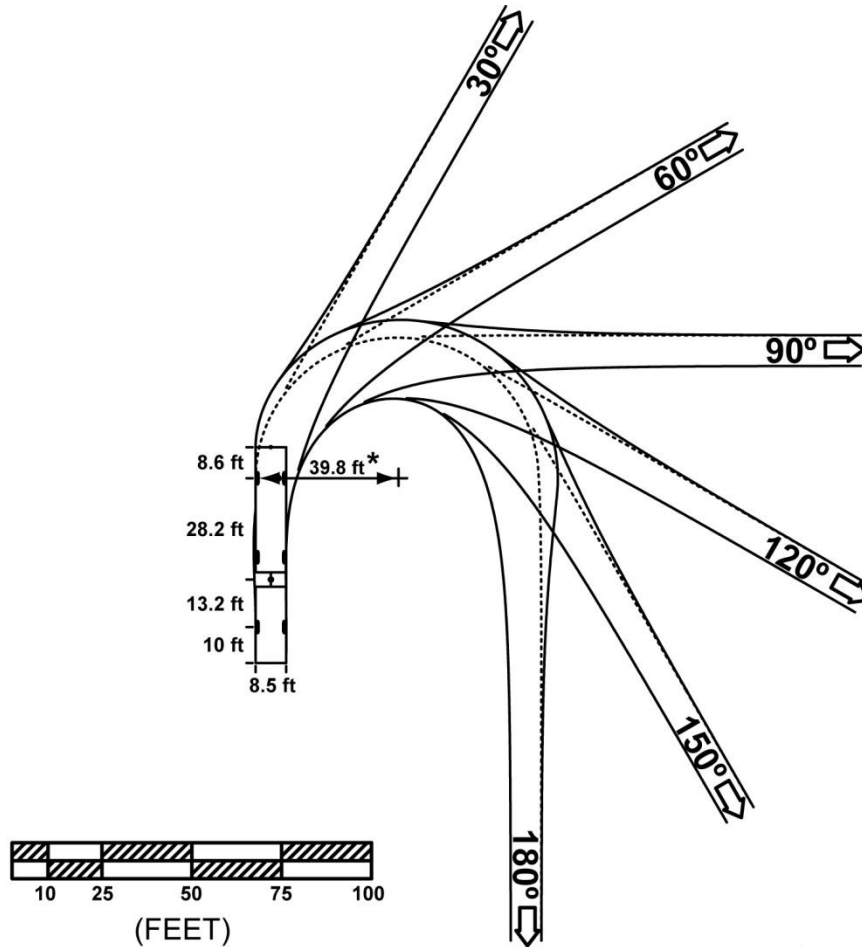

* Radius to outside wheel at beginning of curve.

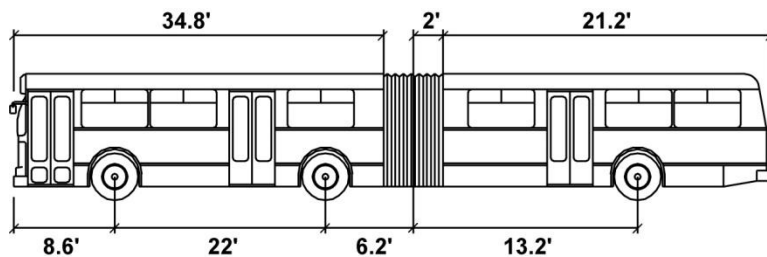

LEGEND

	Swept Width (Body)
	Tracking Width (Tires)

ARTICULATED BUS

- Width : 8.5'
- Track : 8.5'
- Lock to Lock Time : 6 seconds
- Steering Lock Angle: 38.3 degrees
- Articulating Angle : 50.0 degrees

Note: For definitions, see Indexes 404.1 and 404.5.

July 1, 2020

- (5) *Lock To Lock Time* - The time in seconds that an average driver would take under normal driving conditions to turn the steering wheel of a vehicle from the lock position on one side to the lock position on the other side. The default in AutoTurn software is 6 seconds.
- (6) *Steering Lock Angle* - The maximum angle that the steering wheels can be turned. It is further defined as the average of the maximum angles made by the left and right steering wheels with the longitudinal axis of the vehicle.
- (7) *Articulating Angle* - The maximum angle between the tractor and semitrailer.

Topic 405 – Intersection Design Standards

405.1 Sight Distance

- (1) *Stopping Sight Distance*. See Index 201.1 for minimum stopping sight distance requirements.
- (2) *Corner Sight Distance*.

- (a) General. At unsignalized intersections a substantially clear line of sight should be maintained between the driver of a vehicle, bicyclist or pedestrian stopped on the minor road and the driver of an approaching vehicle on the major road that has no stop. Line of sight for all users should be included in right of way, in order to preserve sight lines.

See DIB 79 for 2R, 3R, certain storm damage, protective betterment, operational, and safety projects on two-lane and three-lane conventional highways.

Adequate time should be provided for the stopped vehicle on the minor road to either cross all lanes of through traffic, cross the near lanes and turn left, or turn right, without requiring through traffic to radically alter their speed. The visibility required for these maneuvers form a clear sight triangle with the corner sight distance b and the crossing distance a_1 or a_2 (see Figure 405.1 as an example of corner sight distance at a two-lane, two-way highway). Dimensions a_1 and a_2 are measured from the decision point to the center of the lane. The actual number of lanes will vary on the major and minor roads. There should be no sight obstruction within the clear sight triangle.

The methodology used for the driver on the minor road that is stopped to complete the necessary maneuver while the approaching vehicle travels at the design speed of the major road is based on gap-acceptance behavior. A 7-1/2 second criterion is applied to a passenger car (including pickup trucks) for a left turn from a stop on the minor road. However, this time gap does not account for a single-unit truck (no semitrailer), a combination truck (see Index 404.4 for truck tractor-semi-trailer guidance), a right-turn from a stop, or for a crossing maneuver. See Table 405.1A for the time gap that addresses these situations for the assumed design vehicle making these maneuvers from the minor road.

In determining corner sight distance, a set back distance for the vehicle waiting on the minor road must be assumed as measured from the edge of traveled way of the major road. Set back for the driver of the vehicle on the minor road should be a minimum of 10 feet plus the shoulder width of the major road but not less than 15 feet. The location of the driver's eye for the set back is the decision point per Figure 405.1. Corner sight distance and the driver's eye set back are also illustrated in Figures 405.7 and 504.3I. Line of sight for corner sight distance for passenger cars is to be determined from a 3 and 1/2-foot height at the location of the driver of the vehicle in the center of the minor road lane to a 3 and 1/2-foot object height in the center of the approaching outside lane of the major road. This provides for reciprocal sight by both vehicles. The passenger

car driver's eye height should be applied to all minor roads. In addition, a truck driver's eye height of 7.6 feet should be applied to the minor road where applicable. Additionally, if the major road has a median barrier, a 2-foot object height should be used to determine the median barrier set back. A median that is wide enough to accommodate a stopped vehicle should also provide a clear sight triangle.

The minimum corner sight distance (feet) should be determined by the equation: $1.47V_mT_g$, where V_m is the design speed (mph) of the major road and T_g is the time gap (seconds) for the minor road vehicle to enter the major road. The values given in Table 405.1A should be used to determine T_g based on the design vehicle, the type of maneuver, and whether the stopped vehicle's rear wheels are on an upgrade exceeding 3 percent. The distance from the edge of traveled way to the rear wheels at the minor road stop location should be assumed as: 20 feet for a passenger car, 30 feet for a single-unit truck, and 72 feet for a combination truck.

- (b) Public Road Intersections (Refer to Topic 205 and Index 405.7); corner sight distance applies, see Table 405.1A.

At signalized intersections the corner sight distances should also be applied whenever possible. Even though traffic flows are designed to move at separate times, unanticipated conflicts can occur due to violation of signal, right turns on red, malfunction of the signal, or use of flashing red/yellow mode.

The minimum value for corner sight distance at signalized intersections should be equal to the stopping sight distance as given in Table 201.1, measured as previously described. This includes an urban driveway that forms a leg of the signalized intersection.

- (c) Private Road Intersections (Refer to Index 205.2) and Rural Driveways (Refer to Index 205.4); corner sight distance applies, see Table 405.1A. If signalized, the minimum corner sight distance should be equal to the stopping sight distance as given in Table 201.1, measured as previously described.
- (d) Urban Driveways (Refer to Index 205.3); corner sight distance requirements as described above are not applied to urban driveways unless signalized. See Index 405.1(2)(b) underlined standard. If parking is allowed on the major road, parking should be prohibited on both sides of the driveway per the California MUTCD, 3B.19.
- (3) Decision Sight Distance. At intersections where the State route turns or crosses another State route, the decision sight distance values given in Table 201.7 should be used. In computing and measuring decision sight distance, the 3.5-foot eye height and the 0.5-foot object height should be used, the object being located on the side of the intersection nearest the approaching driver.

The application of the various sight distance requirements for the different types of intersections is summarized in Table 405.1B

Table 405.1B

Application of Sight Distance Requirements

Intersection Types	Sight Distance		
	Stopping	Corner	Decision
Private Roads	X	X ⁽¹⁾	
Public Streets and Roads	X	X	
Signalized Intersections	X	X ⁽²⁾	
State Route Intersections & Route Direction Changes, with or without Signals	X	X	X

NOTES:

(1) Per Index 405.1(2)(c), if signalized, the minimum corner sight distance shall be equal to the stopping sight distance as given in Table 201.1. See Index 405.1(2)(a) for setback requirements.

(2) Apply corner sight distance requirements at signalized intersections whenever possible due to unanticipated violations of the signals or malfunctions of the signals. See Index 405.1(2)(b).

(4) *Acceleration Lanes for Turning Moves onto State Highways.* At rural intersections, with “STOP” control on the local cross road, acceleration lanes for left and right turns onto the State facility should be considered. At a minimum, the following features should be evaluated for both the major highway and the cross road:

- divided versus undivided
- number of lanes
- design speed
- gradient
- lane, shoulder and median width
- traffic volume and composition of highway users, including trucks and transit vehicles

Figure 405.1
Corner Sight Distance (b)

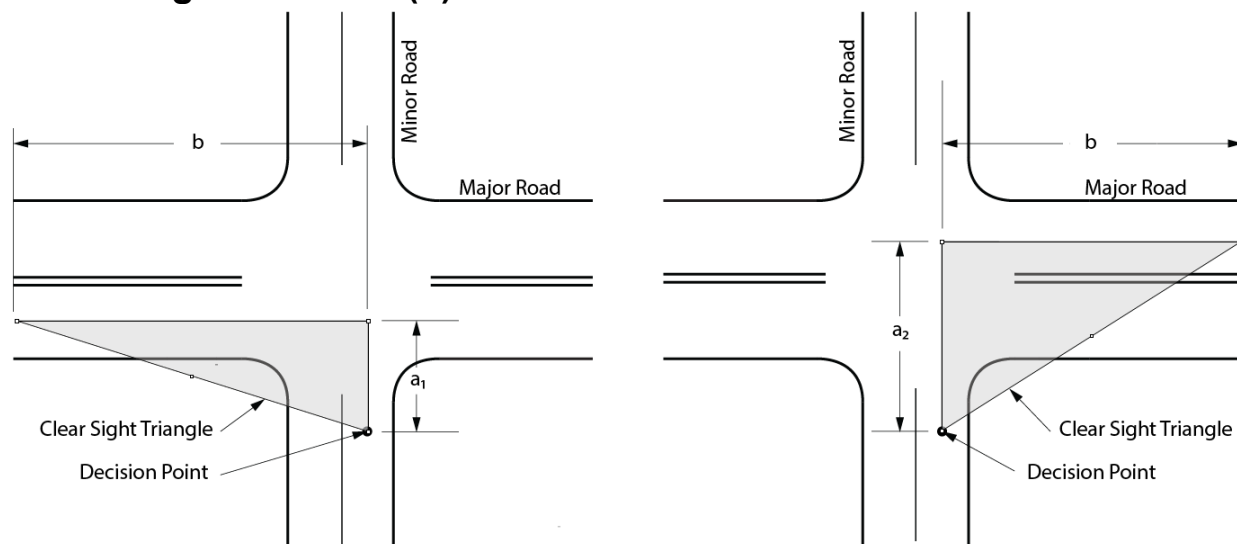

Table 405.1A
Corner Sight Distance Time Gap (T_g) for Unsignalized Intersections

Design Vehicle	Left-turn from Stop (s) ⁽⁴⁾	Right-turn from Stop and Crossing Maneuver (s)
Passenger Car	7½	6½
Private Road Intersection		
Rural Driveway		
Single-Unit Truck	9½	8½
Public Road Intersection		
Combination Truck	11½	10½
Major and Minor Roads on Routes:		
National Network		
Terminal or Service Access		
California Legal		
KPRA Advisory		

Notes: Time gaps are for a stopped vehicle to turn left, right or cross a two-lane highway with no median and with minor road grades of 3 percent or less. The table values should be adjusted as follows:

(1) For multilane highways—When crossing or making a left-turn onto a two-way major road with more than two lanes, add 0.5 s for passenger cars or 0.7 s for trucks for each additional lane to be crossed. Median widths should be converted to an equivalent number of lanes in applying the 0.5 s and 0.7 s criteria. For example, an 18-foot wide median is equivalent to 1.5 lanes; this requires an additional 0.75 s for a passenger car to cross or an additional 1.05 s for a truck to cross.

(2) For minor road approach grades—If the minor road approach grade is an upgrade that exceeds 3 percent and the rear wheels of the design vehicle are on the grade exceeding 3 percent, add 0.2 s for each percent grade for left-turns and crossing maneuvers; or add 0.1 s for each percent grade for right-turns. For example, a passenger car is turning right from a minor road and at the stop location its rear wheels are on a 4 percent upgrade; this requires an additional 0.4 s for the right-turn.

(3) Unique situations may necessitate a different design vehicle for a particular minor road than those listed here (e.g., predominant combination trucks out of a rural driveway). Additionally, for intersections at skewed angles less than 60 degrees, a further adjustment is needed. See the AASHTO “A Policy on Geometric Design of Highways and Streets” for guidance.

(4) Time gap for vehicles approaching from the left can be the same as the right-turn from stop maneuver.

July 1, 2020

- turning volumes
- horizontal curve radii
- sight distance
- proximity of adjacent intersections
- types of adjacent intersections

For additional information and guidance, refer to AASHTO, A Policy on Geometric Design of Highways and Streets, the District Traffic Engineer or designee, the District Design Liaison, and the Project Delivery Coordinator.

405.2 Left-turn Channelization

(1) *General.* The purpose of a left-turn lane is to expedite the movement of through traffic by, controlling the movement of turning traffic, increasing the capacity of the intersection, and improving safety characteristics.

The District Traffic Branch normally establishes the need for left-turn lanes.

(2) *Design Elements.*

(a) Lane Width – **The lane width for both single and double left-turn lanes on State highways shall be 12 feet.**

For conventional State highways with posted speeds less than or equal to 40 miles per hour and AADTT (truck volume) less than 250 per lane that are in urban, city or town centers (rural main streets), the minimum lane width shall be 11 feet.

When considering lane width reductions adjacent to curbed medians, refer to Index 303.5 for guidance on effective roadway width, which may vary depending on drivers' lateral positioning and shy distance from raised curbs.

(b) Approach Taper – On conventional highways without a median, an approach taper provides space for a left-turn lane by moving traffic laterally to the right. The approach taper is unnecessary where a median is available for the full width of the left-turn lane. Length of the approach taper is given by the formula on Figures 405.2A, B and C.

Figure 405.2A shows a standard left-turn channelization design in which all widening is to the right of approaching traffic and the deceleration lane (see below) begins at the end of the approach taper. This design should be used in all situations where space is available, usually in rural and semi-rural areas or in urban areas with high traffic speeds and/or volumes.

Figures 405.2B and 405.2C show alternate designs foreshortened with the deceleration lane beginning at the 2/3 point of the approach taper so that part of the deceleration takes place in the through traffic lane. Figure 405.2C is shortened further by widening half (or other appropriate fraction) on each side. These designs may be used in urban areas where constraints exist, speeds are moderate and traffic volumes are relatively low.

Figure 405.2A
Standard Left-turn Channelization

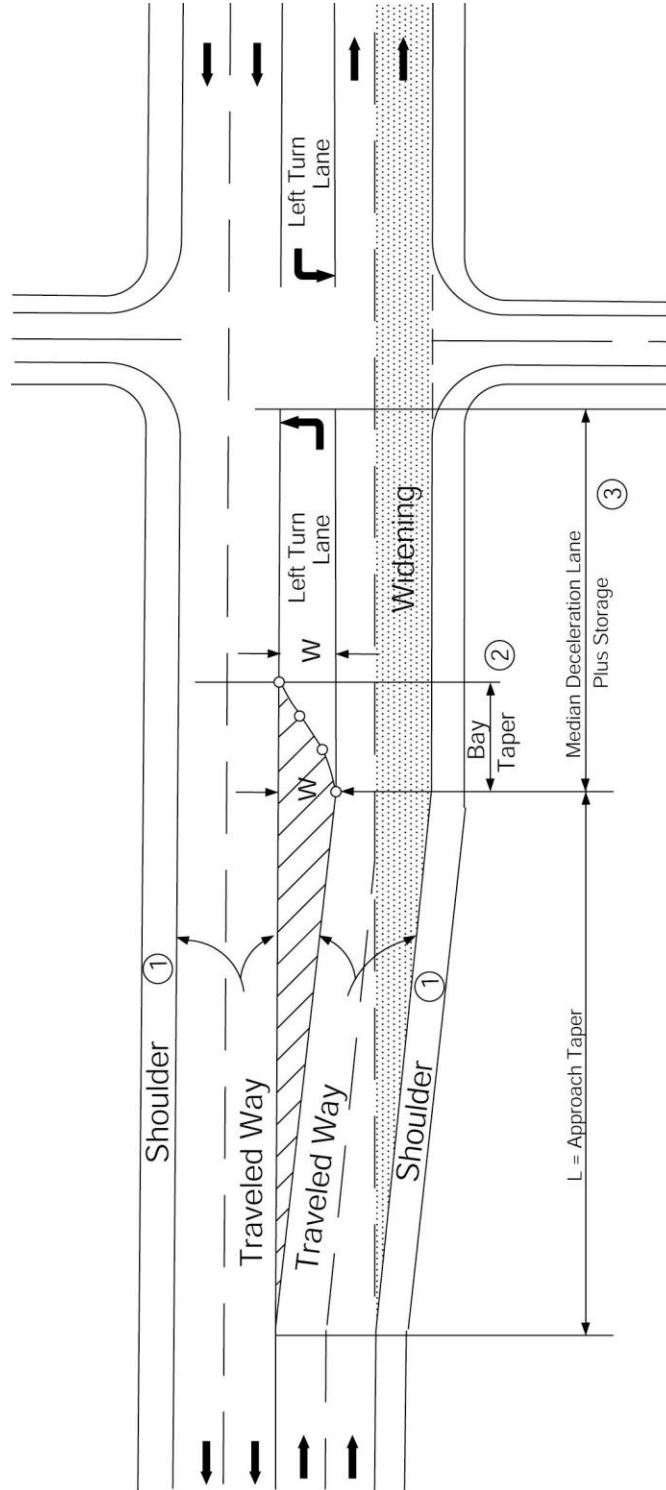

EQUATION: $L = \text{Use } WV, \text{ for } V \geq 45\text{mph}^{(4)}$
 Or $WV^2/60, \text{ for } V < 45\text{mph}$

Where L = Length of Approach Taper - feet

V = Design Speed - mph

W = Width of Median Lane - feet

NOTES:

- ① Where width is restricted, shoulder width may be reduced and parking restricted with an approved design exception pursuant to Index 82.2. For bicycle use, a minimum 4-foot shoulder is required (5-foot if gutter is present).
- ② Bay taper length = 60 feet to 120 feet. (See Table 405.2A)
- ③ For deceleration lane length see Table 405.2B.
- ④ Where both sides of roadway are widened, use a fraction of "W" that is proportional to widening on each side.

July 1, 2020

Figure 405.2B

Minimum Median Left-turn Channelization (Widening on one Side of Highway)

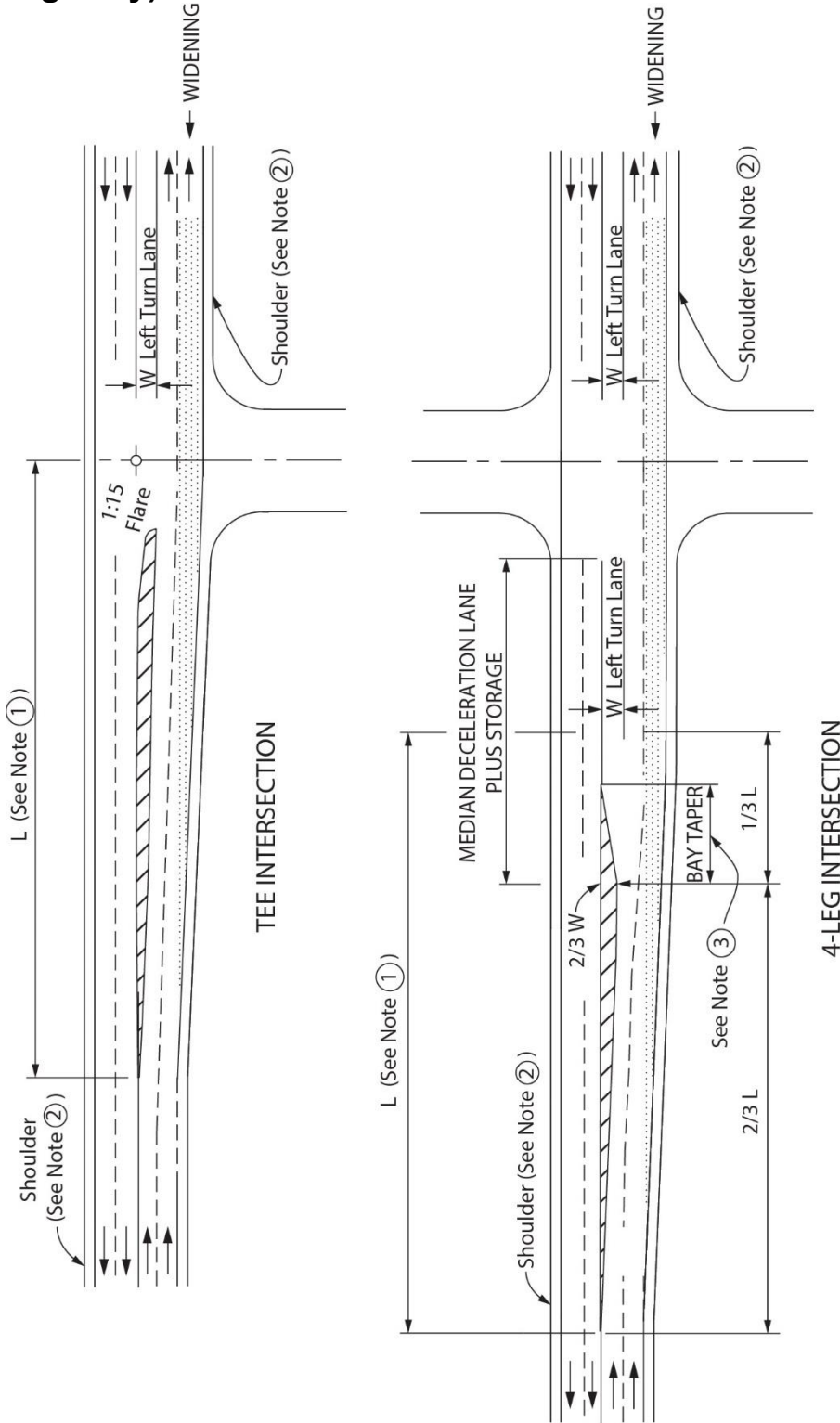

NOTES:

- ① $L = 500$ feet Maximum
- ② Where width is restricted, shoulder width may be reduced and parking restricted with an approved design exception pursuant to Index 82.2. For bicycle use, a minimum 4-foot shoulder is required (5-foot if gutter is required)
- ③ Bay Taper Length 60 feet to 120 feet (See Table 405.2A)

EQUATION

Use WV , for $V \geq 45$ mph
 $L =$ Or $WV^2/60$, for $V < 45$ mph

Where:

- $L =$ Length of Transition - feet
- $W =$ Width of Median Lane - feet
- $V =$ Design Speed - mph

Figure 405.2C

Minimum Median Left-turn Channelization (Widening on Both Sides in Urban Areas with Short Blocks)

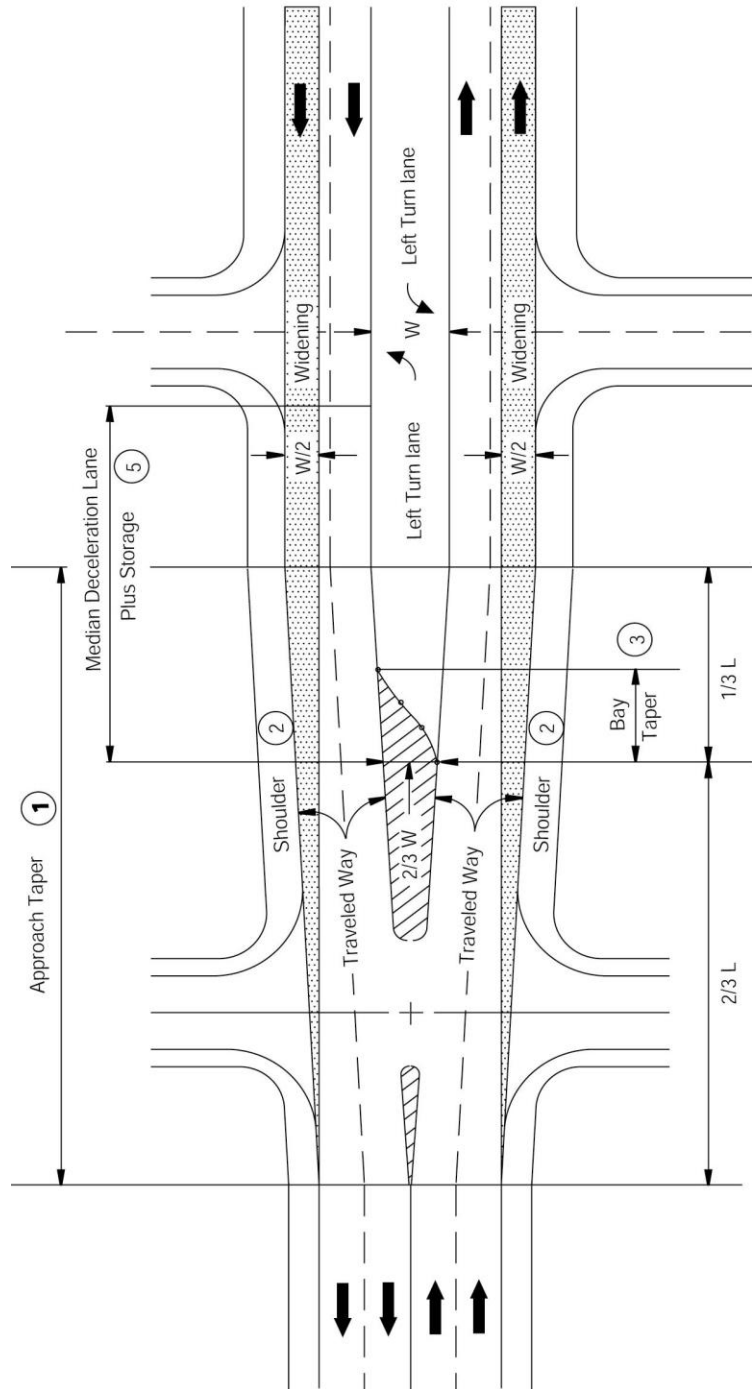

NOTES:

- ① L = 500 feet Maximum
- ② Where width is restricted, shoulder width may be reduced and parking restricted with an approved design exception pursuant to Index 82.2. For bicycle use, a minimum 4 feet shoulder is required (5 feet if gutter is present).
- ③ Bay taper length = 60 feet to 120 feet. (See Table 405.2A)
- ④ Assumes equal widening each side. Where widening is unequal, use a fraction that is proportional to widening on each side.
- ⑤ For deceleration lane length see Table 405.2B.

EQUATION: ④

L = Use $(1/2)WV$, for $V \geq 45\text{mph}$
Or $WV^2/120$, for $V < 45\text{mph}$

Where L = Length of Approach Taper - feet
W = Width of Median Lane - feet
V = Design Speed - mph

July 1, 2020

- (c) Bay Taper – A reversing curve along the left edge of the traveled way directs traffic into the left-turn lane. The length of this bay taper should be short to clearly delineate the left-turn move and to discourage through traffic from drifting into the left-turn lane. Table 405.2A gives offset data for design of bay tapers. In urban areas, lengths of 60 feet and 90 feet are normally used. Where space is restricted and speeds are low, a 60-foot bay taper is appropriate. On rural high-speed highways, a 120-foot length is considered appropriate.
- (d) Deceleration Lane Length – Design speed of the roadway approaching the intersection should be the basis for determining deceleration lane length. It is desirable that deceleration take place entirely off the through traffic lanes. Deceleration lane lengths are given in Table 405.2B; the bay taper length is included. Where partial deceleration is permitted on the through lanes, as in Figures 405.2B and 405.2C, design speeds in Table 405.2B may be reduced 10 miles per hour to 20 miles per hour for a lower entry speed. In urban areas where cross streets are closely spaced and deceleration lengths cannot be achieved, the District Traffic branch should be consulted for guidance.
- (e) Storage Length – At unsignalized inter-sections, storage length may be based on the number of turning vehicles likely to arrive in an average 2-minute period during the peak hour. At a minimum, space for 2 vehicles should be provided at 25 feet per vehicle. If the peak hour truck traffic is 10 percent or more, space for at least one passenger car and one truck should be provided. Bus usage may require a longer storage length and should be evaluated if their use is anticipated.

At signalized intersections, the storage length may be based on one and one-half to two times the average number of vehicles that would store per signal cycle depending on cycle length, signal phasing, and arrival and departure rates. At a minimum, storage length should be calculated in the same manner as unsignalized intersection. The District Traffic Branch should be consulted for this information.

When determining storage length, the end of the left-turn lane is typically placed at least 3 feet, but not more than 30 feet, from the nearest edge of shoulder of the intersecting roadway. Although often set by the placement of a crosswalk line or limit line, the end of the storage lane should always be located so that the appropriate turning template can be accommodated.

Table 405.2A

Bay Taper for Median Speed-change Lanes

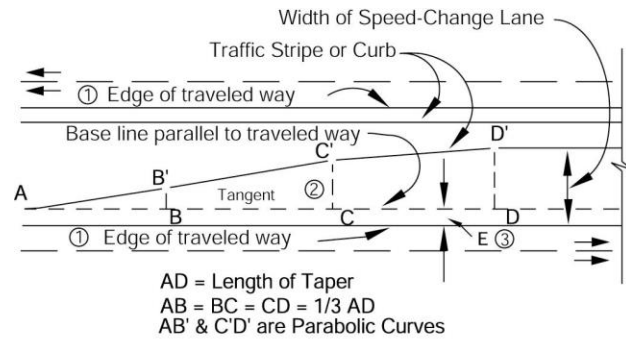

LENGTH OF TAPER - feet			OFFSET DISTANCE			
60	90	120	DD' = 10'	DD' = 11'	DD' = 12'	
Distance From Point "A"						
-	-	-	0.00	0.00	0.00	
5	7.5	10.0	0.16	0.17	0.19	
10	15.0	20.0	0.62	0.69	0.75	
15	22.5	30.0	1.41	1.55	1.69	
B'	20	30.0	40.0	2.50	2.75	3.00
	30	45.0	60.0	5.00	5.50	6.00
C'	40	60.0	80.0	7.50	8.25	9.00
	45	67.5	90.0	8.59	9.45	10.31
	50	75.0	100.0	9.38	10.31	11.25
	55	82.5	110.0	9.84	10.83	11.81
	60	90.0	120.0	10.00	11.00	12.00

NOTES:

- (1) The table gives offsets from a base line parallel to the edge of traveled way at intervals measured from point "A". Add "E" for measurements from edge of traveled way.
- (2) Where edge of traveled way is a curve, neither base line nor taper between B & C will be a tangent. Use proportional offsets from B to C.
- (3) The offset "E" is usually 2 ft along edge of traveled way for curbed medians; Use "E" = 0 ft. for striped medians.

Table 405.2B

Deceleration Lane Length

Design Speed (mph)	Length to Stop (ft)
30	235
40	315
50	435
60	530

July 1, 2020

- (3) *Double Left-turn Lanes.* At signalized intersections on multilane conventional highways and on multilane ramp terminals, double left-turn lanes should be considered if the left-turn demand is 300 vehicles per hour or more. The lane widths and other design elements of left-turn lanes given under Index 405.2(2) applies to double as well as single left-turn lanes.

The design of double left-turn lanes can be accomplished by adding one or two lanes in the median. See "Complete Intersections: A Guide to Reconstructing Intersections and Interchanges for Bicyclists and Pedestrians", published by Headquarters, Division of Traffic Operations, for the various treatments of double left-turn lanes.

- (4) *Two-way Left-turn Lane (TWLTL).* The TWLTL consists of a striped lane in the median of an arterial and is devised to address the special capacity and safety problems associated with high-density strip development. It can be used on 2-lane highways as well as multilane highways. Normally, the District Traffic Operations Branch should determine the need for a TWLTL.

The minimum width for a TWLTL shall be 12 feet (see Index 301.1). The preferred width is 14 feet. Wider TWLTL's are occasionally provided to conform with local agency standards. However, TWLTL's wider than 14 feet are not recommended, and in no case should the width of a TWLTL exceed 16 feet. Additional width may encourage drivers in opposite directions to use the TWLTL simultaneously.

405.3 Right-turn Channelization

- (1) *General.* For right-turning traffic, delays are less critical and conflicts less severe than for left-turning traffic. Nevertheless, right-turn lanes can be justified on the basis of capacity, analysis, and crash experience.

In rural areas a history of high speed rear-end collisions may warrant the addition of a right-turn lane.

In urban areas other factors may contribute to the need such as:

- High volumes of right-turning traffic causing backup and delay on the through lanes.
- Conflicts between crossing pedestrians and right-turning vehicles and bicycles.
- Frequent rear-end and sideswipe collisions involving right-turning vehicles.

Where right-turn channelization is proposed, lower speed right-turn lanes should be provided to reduce the likelihood of conflicts between vehicles, pedestrians, and bicyclists.

- (2) *Design Elements.*

- (a) Lane and Shoulder Width – **Index 301.1 shall be used for right-turn lane width requirements. Shoulder width shall be a minimum of 4 feet.** Although not desirable, lane and shoulder widths less than those given above can be considered for right-turn lanes under the following conditions pursuant to Index 82.2:

- In urban, city or town centers (rural main streets) with posted speeds less than 40 miles per hour in severely constrained situations, if truck or bus use is low, consideration may be given to reducing the right-turn lane width to 10 feet.
- Shoulder widths may also be considered for reduction under constricted situations. Whenever possible, at least a 2-foot shoulder should be provided where the right-turn lane is adjacent to a curb. Entire omission of the shoulder should only be considered in constrained situations and where an 11-foot lane can be constructed.

Gutter pans can be included within a shoulder, but cannot be included as part of the travel lane width. Additional right of way for a future right-turn lane should be considered when an intersection is being designed.

- (b) Curve Radius--Where pedestrians are allowed to cross a free right-turning roadway, the curve radius should be such that the operating speed of vehicular traffic is no more than 20 miles per hour at the pedestrian crossing. See NCHRP Report 672, "Roundabouts: An Informational Guide" for guidance on the determination of design speed (fastest path) for turning vehicles. See Index 504.3(3) for additional information.
 - (c) **Tapers--Approach tapers** are usually unnecessary since main line traffic need not be shifted laterally to provide space for the right-turn lane. If, in some rare instances, a lateral shift were needed, the approach taper would use the same formula as for a left-turn lane. Bay tapers are treated as a mirror image of the left-turn bay taper.
 - (d) **Deceleration Lane Length--**The conditions and principles of left-turn lane deceleration apply to right-turn deceleration. Where full deceleration is desired off the high-speed through lanes, the lengths in Table 405.2B should be used. Where partial deceleration is permitted on the through lanes because of limited right of way or other constraints, average running speeds in Table 405.2B may be reduced 10 miles per hour to 20 miles per hour for a lower entry speed. For example, if the main line speed is 50 miles per hour and a 10 miles per hour deceleration is permitted on the through lanes, the deceleration length may be that required for 40 miles per hour.
 - (e) **Storage Length--**Right-turn storage length is determined in the same manner as left-turn storage length. See Index 405.2(2)(e).
- (3) ***Right-turn Lanes at Off-ramp Intersections.*** Diamond off-ramps with a free right-turn at the local street and separate right-turn off-ramps around the outside of a loop will likely cause conflict as traffic volumes increase. Serious conflicts occur when the right-turning vehicle must weave across multiple lanes on the local street in order to turn left at a major cross street close to the ramp terminal. Furthermore, free right-turns create sight distance issues for pedestrians and bicyclists crossing the off-ramp, or pedestrians crossing the local road. Also, rear-end collisions can occur as right-turning drivers slow down or stop waiting for a gap in local street traffic. Free right-turns usually end up with "YIELD", "STOP", or signal controls thus defeating their purpose of increasing intersection capacity.

405.4 Traffic Islands

A traffic island is an area between traffic lanes for channelization of bicycle and vehicle movements or for pedestrian refuge. An island may be defined by paint, raised pavement markers, curbs, pavement edge, or other devices. The California MUTCD should be referenced when considering the placement of traffic islands at signalized and unsignalized locations. For splitter island guidance at roundabouts, see Index 405.10(13).

Traffic islands usually serve more than one function. These functions may be:

- (a) Channelization to confine specific traffic movements into definite channels;
- (b) Divisional to separate traffic moving in the same or opposite direction; and
- (c) Refuge, to aid users crossing the roadway.

Generally, islands should present the least potential conflict to approaching or crossing bicycles and vehicles, and yet perform their intended function.

July 1, 2020

(1) *Design of Traffic Islands.* Island sizes and shapes vary from one intersection to another. They should be large enough to command attention. Channelizing islands should not be less than 50 square feet in area, preferably 75 square feet. Curbed, elongated divisional median islands should not be less than 4 feet wide and 20 feet long. All traffic islands placed in the path of a pedestrian crossing must comply with DIB 82. See the Standard Plans for typical island passageway details.

The approach end of each island should be offset 3 feet to the left and 5 feet to the right of approaching traffic, using standard 1:15 parabolic flares, and clearly delineated so that it does not surprise the motorist or bicyclist. These offsets are in addition to the shoulder widths shown in Table 302.1. Table 405.4 gives standard parabolic flares to be used in island design. On curved alignment, parabolic flares may be omitted for small triangular traffic islands whose sides are less than 25 feet long.

The approach nose of a divisional island should be highly visible day and night with appropriate use of signs (reflectorized or illuminated) and object markers. The approach nose should be offset 3 feet from the through traffic to minimize accidental impacts.

(2) *Delineation of Traffic Islands.* Generally, islands should present the least potential conflict to approaching traffic and yet perform their intended function. See Index 303.2 for appropriate curb type. Islands may be designated as follows:

- (a) Raised paved areas outlined by curbs.
- (b) Flush paved areas outlined by pavement markings.
- (c) Unpaved areas (small unpaved areas should be avoided).

On facilities with posted speeds over 40 miles per hour, the use of any type of curb is discouraged. Where curbs are to be used, they should be located at or outside of the shoulder edge, as discussed in Index 303.5.

In rural areas, painted channelization supplemented with raised pavement markers may be more appropriate than a raised curbed channelization. This design is as forgiving as possible and decreases the consequence of a driver's or bicyclist's failure to detect or recognize the curbed island. Consideration for snow removal operations should be determined where appropriate.

In urban areas, posted speeds less than or equal to 40 miles per hour allow more frequent use of curbed islands. Local agency requirements and matching existing conditions are factors to consider.

Table 405.4

Parabolic Curb Flares Commonly Used

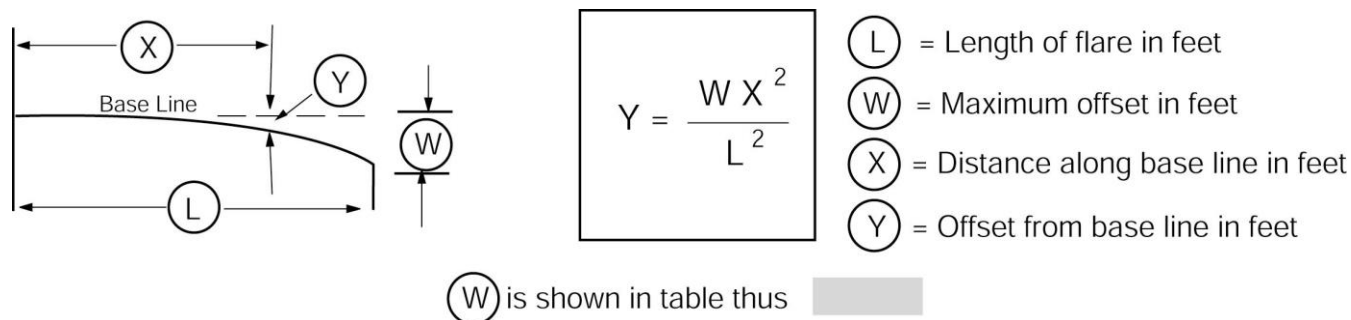

OFFSET IN FEET FOR GIVEN "X" DISTANCE																
0	10	15	20	25	30	40	45	50	60	70	75	80	90	100	110	120
1:5 FLARES																
25	0.8	1.8	3.2	5.0												
50	0.4		1.6		3.6	6.4		10.								
1:10 FLARES																
50	0.2		0.8		1.8	3.2		5.0								
100	0.1		0.4		0.9	1.6		2.5	3.6	4.9		6.4	8.1	10.		
1:15 FLARES																
45	0.1		0.5		1.3	2.3	3.0									
75	0.0		0.3		0.8	1.4		2.2	3.2	4.3	5.0					
90	0.0		0.3		0.6	1.1		1.8	2.6	3.6		4.7	6.0			
120	0.0		0.2		0.5	0.8		1.3	2.0	2.7		3.5	4.5	5.5	6.7	8.0

(3) *Pedestrian Refuge.* Pedestrian refuge islands allow pedestrians to cross fewer lanes at a time while judging conflicts separately. They also provide a refuge so slower pedestrians can wait for a gap in traffic while reducing total crossing distance.

At unsignalized intersections in rural city/town centers (rural main streets), suburban, or urban areas, a pedestrian refuge should be provided between opposing traffic where pedestrians are allowed to cross 2 or more through traffic lanes in one direction of travel, at marked or unmarked crosswalks. Pedestrian islands at signalized crosswalks should be considered, taking into account crossing distance and pedestrian activity. Note that signalized pedestrian crossings must be timed to allow for pedestrians to cross. See the California MUTCD, Chapter 4E, for further guidance.

Traffic islands used as pedestrian refuge are to be large enough to provide a minimum of 6 feet in the direction of pedestrian travel, without exception.

All traffic islands placed in the path of a pedestrian crossing must be accessible, refer to DIB 82 and the Standard Plans for further guidance. An example of a traffic island that serves as a pedestrian refuge is shown on Figure 405.4.

July 1, 2020

405.5 Median Openings

- (1) *General.* Median openings, sometimes called crossovers, provide for crossings of the median at designated locations. Except for emergency passageways in a median barrier, median openings are not allowed on urban freeways.
- (2) *Spacing and Location.* By a combination of interchange ramps and emergency passageways, provisions for access to the opposite side of a freeway may be provided for law enforcement, emergency, and maintenance vehicles to avoid extreme out-of-direction travel. Access should not be more frequent

Figure 405.4

Pedestrian Refuge Island

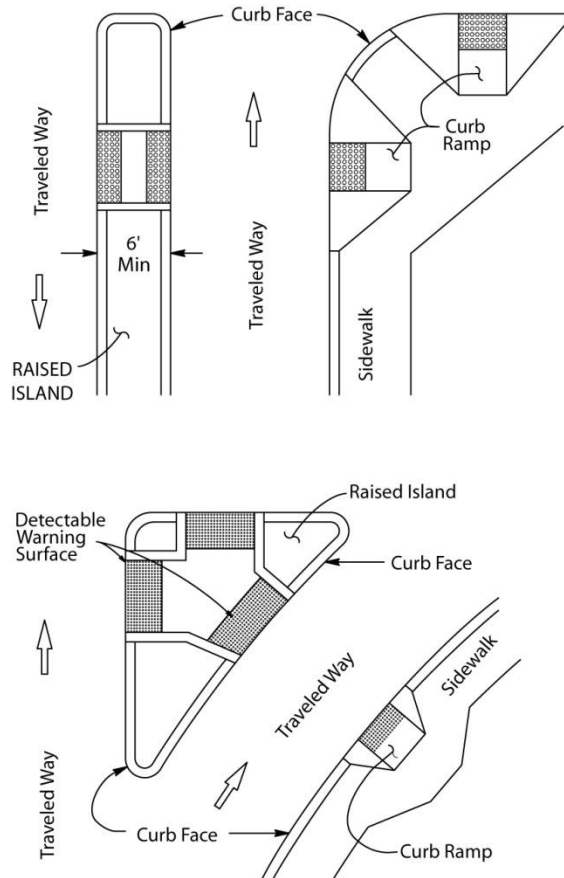

than at three-mile intervals. See Traffic Safety Systems Guidance for additional information on the design of emergency passageways.

Emergency passageways should be located only where decision sight distance is available (see Table 201.7).

Median openings at close intervals on other types of highways create conflicts with high speed through traffic. Median openings should be spaced at intervals no closer than 1600 feet. If a median opening falls within 300 feet of an access opening, it should be placed opposite the access opening.

- (3) *Length of Median Opening.* For any three or four-leg intersection on a divided highway, the length of the median opening should be at least as great as the width of the crossroads pavement, median width, and shoulders. An important factor in designing median openings is the path of the design vehicle making a minimum left turn at 5 miles per hour to 10 miles per hour. The length of median opening varies with width of median and angle of intersecting road.

Usually a median opening of 60 feet is adequate for 90 degree intersections with median widths of 22 feet or greater. When the median width is less than 22 feet, a median opening of 70 feet is needed. When the intersection angle is other than 90 degrees, the length of median opening should be established by using truck turn templates (see Index 404.3).

- (4) *Cross Slope.* The cross slope in the median opening should be limited to 5 percent. Crossovers on curves with super elevation exceeding 5 percent should be avoided. This cross slope may be exceeded when an existing 2-lane roadbed is converted to a 4-lane divided highway. The elevation of the new construction should be based on the 5 percent cross slope requirement when the existing roadbed is raised to its ultimate elevation.
- (5) *References.* For information related to the design of intersections and median openings, "A Policy on Geometric Design of Highways and Streets," AASHTO, should be consulted.

405.6 Access Control

The basic guidance which govern the extent to which access rights are to be acquired at interchanges (see Topic 104, Index 205.1 and 504.8 and the PDPM) also apply to intersections at grade on expressways. Cases of access control which frequently occur at intersections are shown in Figure 405.7. This illustration does not presume to cover all situations. Where required by traffic conditions, access should be extended in order to ensure proper operation of the expressway lanes. Reasonable variations which observe the basic principles referred to above are acceptable.

However, negative impacts on the mobility needs of pedestrians, bicyclists, equestrians, and transit users need to be assessed. Pedestrians and bicyclists are sensitive to additional out of direction travel.

July 1, 2020

Figure 405.5

Typical Design for Median Openings

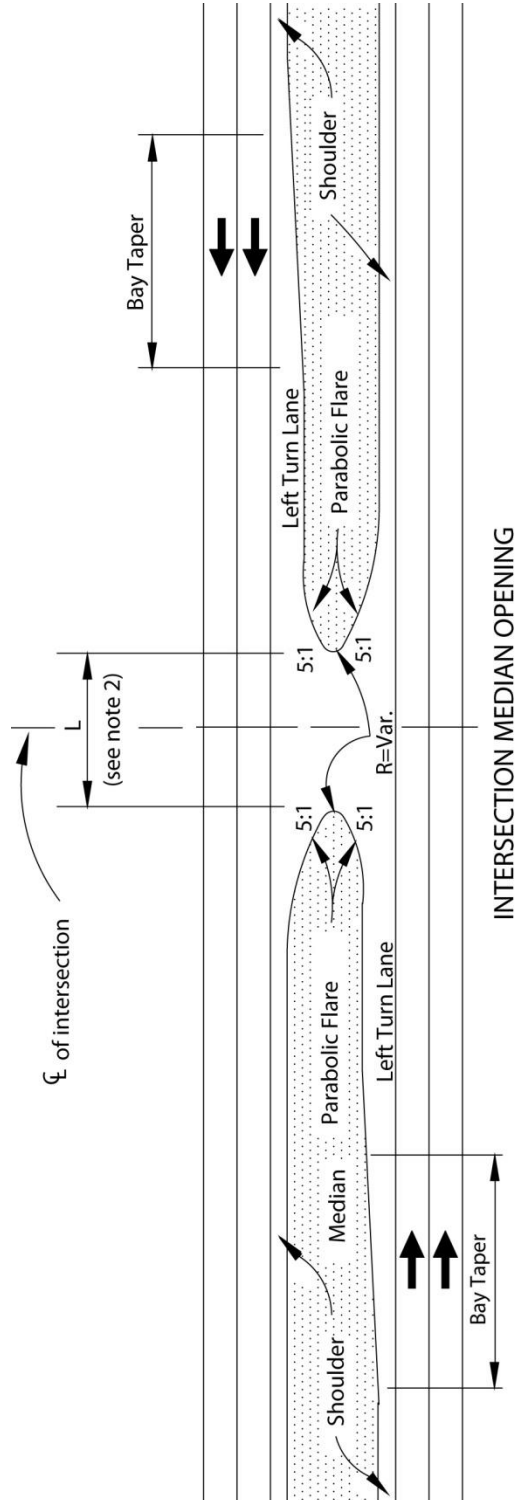

NOTES:

- ① For length of bay taper, see Table 405.2A.
- ② L = Length of median opening: varies with width of median and angle of intersecting road. Usually for 90° intersection, L = 60 feet for median of 22 feet and wider. L = 70 feet for medians narrower than 22 feet.
- ③ See Index 405.2.
- ④ Pedestrian and bicycle features are not shown on figure.

405.7 Public Road Intersections

The basic design to be used at right-angle public road intersections on the State Highway System is shown in Figure 405.7. The essential elements are sight distance (see Index 405.1) and the treatment of the right-turn on and off the main highway. Encroachment into opposing traffic lanes by the turning vehicle should be avoided or minimized.

- (1) *Right-turn Onto the Main Highway.* The combination of a circular curve joined by a 2:1 taper on the crossroads and a 75-foot taper on the main highway is designed to fit the wheel paths of the appropriate turning template chosen by the designer.

It is desirable to keep the right-turn as tight as practical, so the “STOP” or “YIELD” sign on the minor leg can be placed close to the intersection.

- (2) *Right-turn Off the Main Highway.* The combination of a circular curve joined by a 150-foot taper on the main highway and a 4:1 taper on the crossroads is designed to fit the wheel paths of the appropriate turning template and to move the rear of the vehicle off the main highway. Deceleration and storage lanes may be provided when necessary (see Index 405.3).

- (3) *Alternate Designs.* Offsets are given in Figure 405.7 for right angle intersections. For skew angles, roadway curvature, and possibly other reasons, variations to the right-angle design are permitted, but the basic rule is still to approximate the wheel paths of the design vehicle.

A three-center curve is an alternate treatment that may be used at the discretion of the designer.

Intersections are major consideration in bicycle path design as well. See Indexes 403.6 and 1003.1(5) for general bicycle path intersection design guidance. Also see Section 5.3 of the AASHTO Guide for the Planning, Design, and Operation of Bicycle Facilities.

405.8 City Street Returns and Corner Radii

The pavement width and corner radius at city street intersections is determined by the type of vehicle to be accommodated and the mobility needs of pedestrians and bicyclists, taking into consideration the amount of available right of way, the types of adjoining land uses, the place types, the roadway width, and the number of lanes on the intersecting street.

At urban intersections, the California truck or the Bus Design Vehicle template may be used to determine the corner radius. Where STAA truck access is allowed, the STAA Design Vehicle template should be used giving consideration to factors mentioned above. See Index 404.3.

Smaller radii of 15 feet to 25 feet are appropriate at minor cross streets where few trucks or buses are turning. Local agency standards may be appropriate in urban and suburban areas.

Encroachment into opposing traffic lanes must be avoided.

405.9 Widening of 2-lane Roads at Signalized Intersections

Two-lane State highways may be widened at intersections to 4-lanes whenever signals are installed. Sometimes it may be necessary to widen the intersecting road. The minimum design is shown in Figure 405.9. More elaborate treatment may be warranted by the volume and

July 1, 2020

Figure 405.7

Public Road Intersections

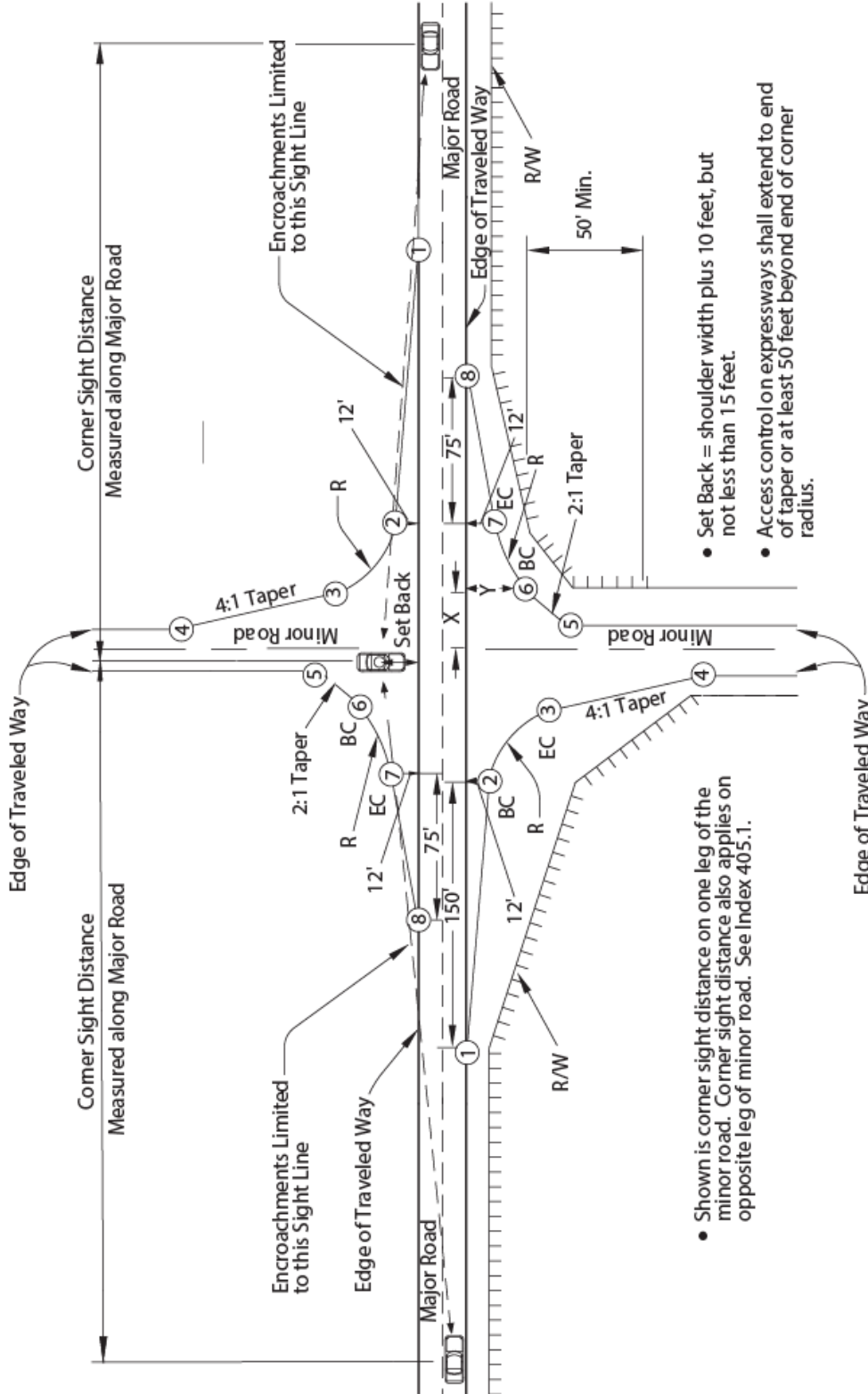

X - Distance measured from centerline of minor road along major road - feet.
 Y - Offset distance measured from edge of traveled way of major road to any given point - feet.

Radius of Curve	Pt ①		Pt ②		Pt ③		Pt ④		Pt ⑤		Pt ⑥		Pt ⑦		Pt ⑧	
	X	Y	X	Y	X	Y	X	Y	X	Y	X	Y	X	Y	X	Y
30'	204.20	0.0	54.20	12.0	27.49	34.63	12.0	96.58	12.0	40.66	18.23	28.21	40.32	12.0	115.32	0.0
40'	215.08	0.0	65.08	12.0	29.46	42.17	12.0	112.03	12.0	53.35	21.87	33.61	51.33	12.0	126.33	0.0
50'	226.09	0.0	76.09	12.0	31.57	49.71	12.0	127.98	12.0	75.63	30.31	39.01	67.13	12.0	142.13	0.0

Figure 405.9

Widening of Two-lane Roads at Signalized Intersections

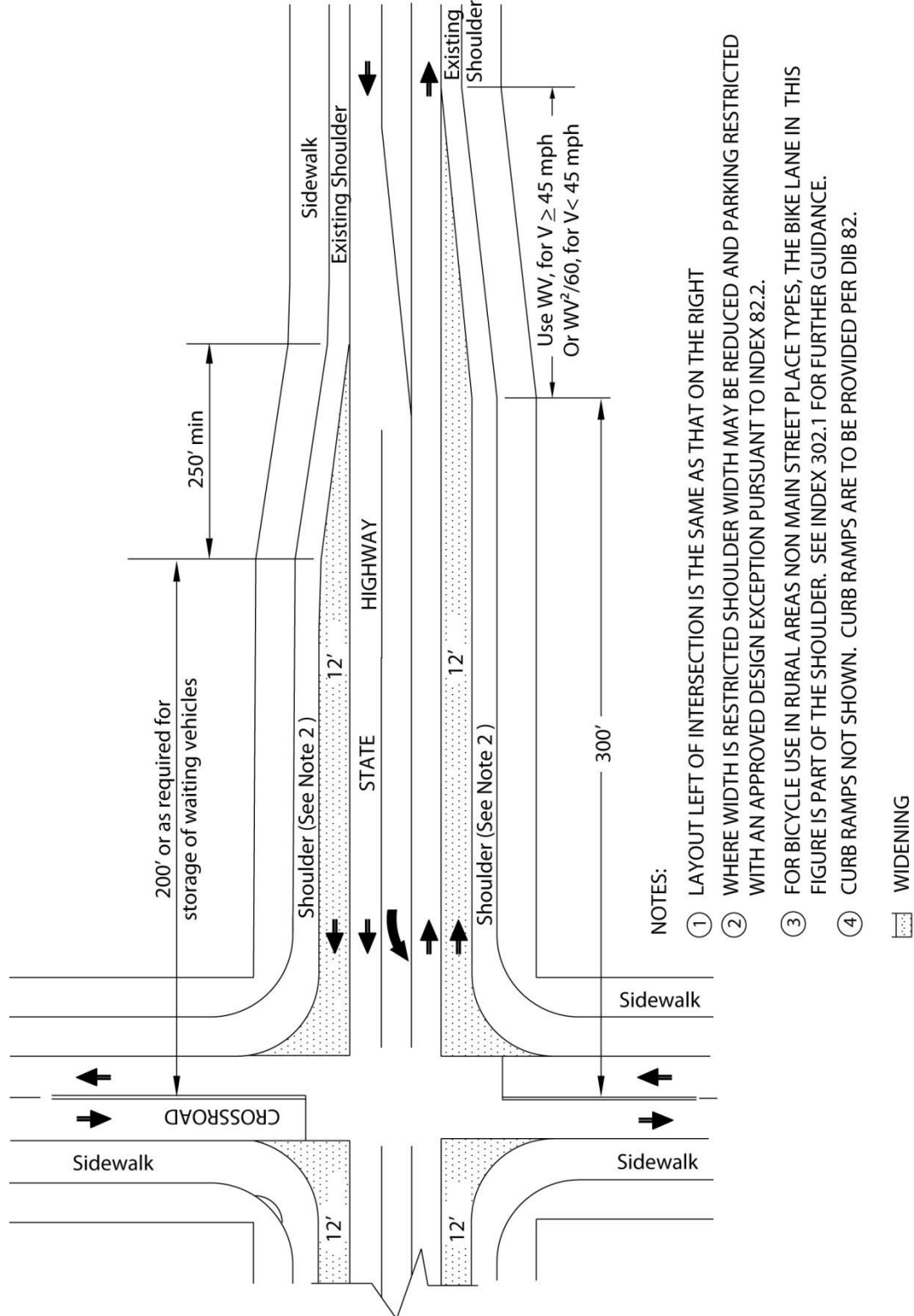

May 20, 2022

pattern of traffic movements. Unusual turning movement patterns may possibly call for a different shape of widening.

The impact on pedestrian and bicycle traffic mobility of larger intersections should be assessed before a decision is made to widen an intersection.

405.10 Roundabouts

Roundabout intersections on the State highway system must be developed and evaluated in accordance with National Cooperative Highway Research Program (NCHRP) Report 672 entitled "Roundabouts: An Informational Guide, Second Edition" dated October 2010 and Traffic Operations Policy Directive (TOPD) Number 13-02. Also see Index 401.5 for general information and guidance. See Figure 405.10A Roundabout Geometric Elements for nomenclature associated with roundabouts. Signs, striping and markings at roundabouts are to comply with the California MUTCD.

A roundabout is a form of circular intersection in which traffic travels counterclockwise around a central island and entering traffic must yield to the circulating traffic. Roundabouts feature, among other things, a central island, a circulatory roadway, and splitter islands on each approach. Roundabouts rely upon two basic and important operating principles:

- (a) Geometric design that reduce speeds at the entry and through the intersection, and
- (b) The yield-at-entry rule, which requires traffic entering the intersection to yield to traffic that is traveling in the circulatory roadway.

Some benefits of roundabouts include:

- Fewer conflict points, especially the high angle conflict points, which results in less severe crashes when compared to the stop-controlled or signal-controlled intersections. Over half of vehicle to vehicle conflict points associated with stop- and signal-controlled intersections are eliminated with the use of a roundabout. Additionally, a roundabout separates the conflict points which eases the ability of the driver, pedestrian, or bicyclist to identify a conflict and helps prevent conflicts from becoming crashes.
- Roundabouts are designed to reduce the vehicular speeds at intersections. Lower speeds lessen the vehicular crash severity. Likewise, studies indicate that when motorized vehicles are traveling at slower speeds, crash severity with pedestrian and bicyclist is significantly reduced; hence, roundabouts are proven safety countermeasures for traffic calming for complete street designs.
- Roundabouts are yield-controlled intersections, which allow continuous free flow of vehicles, pedestrians, and bicycles when no conflicts exist. This results in less noise and air pollution and reduces overall delays at roundabout intersections. Additionally, since there is no traffic signal, the operations are not affected by power outages.
- Roundabouts tend to have less delay and reduce greenhouse gases when compared to stop-controlled or signal controlled intersections.

Except as indicated in this Index, the design standards elsewhere in this manual do not apply within the boundaries of roundabouts. The boundary of a roundabout intersection is defined as follows:

- If the roadway is undivided, use the approach ends of the splitter islands.

Figure 405.10A

Roundabout Geometric Elements

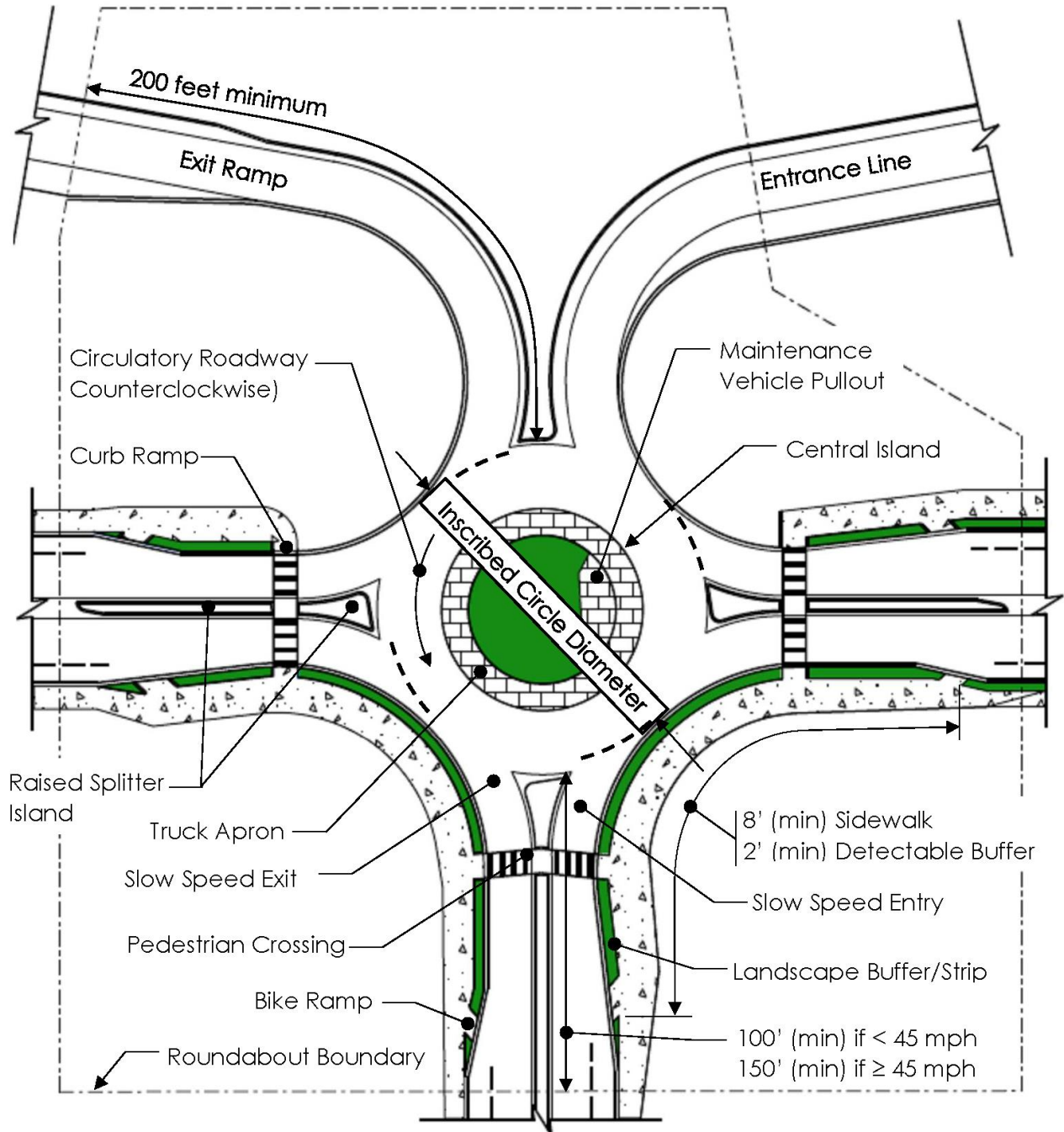

NOTE:

This figure is provided to show only nomenclature and a roundabout boundary example. This figure is not to be used for design details.

May 20, 2022

- If the roadway is physically divided (such as a raised median), use 100 feet from the inscribed circle diameter (ICD) for roadways with posted speeds less than 45 miles per hour or 150 feet from the ICD for roadways with posted speeds equal to or greater than 45 miles per hour.
- For freeway exit ramps, a minimum of 200 feet from the ICD.
- For freeway entrance ramps, a minimum of 50 feet from the ICD or 20 feet past the crosswalk, whichever is further from the ICD.
- If successive curves are used, also known as a chicane (NCHRP Report 672, Exhibit 6-70), use the beginning of the chicane as the boundary.

See Figure 405.10A for a typical roundabout boundary example.

(1) *Design Period.* The 20-year design period required by Index 103.2 applies to roundabouts. Within the required design period, a single lane roundabout may provide operational benefits for 10 or more years before a multilane configuration is necessary, depending on traffic demand. In these situations, consideration should be given to build a single lane roundabout as an initial phase of a multilane roundabout. The multilane roundabout is designed, first, and needs to meet the performance checks for a multilane roundabout configuration. The single lane roundabout is designed from the multilane design by curbing out portions of the multilane roundabout to meet all the performance checks for a single lane configuration. This approach will maximize the safety and operational benefits during the initial and final phases of the improvements. In order to comply with the design period requirement, the initial project must provide the right of way needed for utility relocations, a shared-use path designed for a Class I Bikeway, and all other features other than pavement, lighting, and striping in their ultimate locations.

Another method to meet the 20-year design period is to determine if metering one or more of the legs would allow a single lane roundabout to function for the life of the project.

In some locations, it may not be practical to build a single lane roundabout that will operate for 10 years. Geometric constraints and other conflicts may preclude widening to the ultimate configuration. In such cases, other intersection configurations or control strategies addressed in Index 401.5 may need to be considered.

When intersection improvements are to be phased, see NCHRP Report 672, Section 6.12.

(2) *Design Vehicles.* See Topic 404. Each roundabout has three design vehicles that need to be considered. 1) The largest vehicle to pass through the roundabout without using the truck apron. These would include, but not limited to, large vehicles transporting passengers with injuries, physical disabilities, the elderly, and transit vehicles. Other large vehicles included with this consideration are those where shifting of vehicle contents would be undesirable, such as fire engines and single-unit delivery vehicles. 2) California Legal or STAA trucks. These are discussed below in more detail. 3) Permit vehicles (oversize/overweight) that need to be able to pass through the roundabout. Accommodations for permit vehicles are further discussed below.

The turning path for the design vehicle, dictates many of the roundabout dimensions, see Index 404.5. The design vehicle wheel tracking and swept width are to be used when designing all entries, exits, and the circulatory roadway (see Index 404.2). To maximize the safety benefits and preserve operations, roundabouts should be designed to be as small as possible and incorporate truck aprons to facilitate truck movements rather than increasing the size of the roundabout. Accommodations for trucks includes the use of truck aprons where necessary, while balancing other factors such as pedestrian accommodation.

When more than one entry lane or circulating lane is available, truck drivers prefer to take control of the intersection by: 1) taking both lanes on entry to prevent a vehicle from entering their blind spots or overtaking during entry (as they would with a turn at any other intersection configuration); and 2) encroaching into adjacent lanes while circulating to protect their blind spots and prevent overtaking. During a turning movement, a truck's entire outside of the trailer (passenger side for left turns) becomes a large blind spot. To protect this blind spot and reduce the risk of colliding with an unseen vehicle, truck drivers may even prefer to stay in the outside lane while circulating to make through, left turn, and u-turn movements. Roundabouts with multilane entries or circulating lanes should be designed with the understanding that most truck drivers will not stay within the lane lines.

Oversize/Overweight permit vehicles are oftentimes larger than other design vehicles, but are essential to move goods throughout the state. Due to the critical nature of goods and services, which these vehicle transport, permit vehicles must also be considered in the design of intersections. Traditional signal or stop controlled intersections are typically not an issue for most of the oversize/overweight vehicles to pass through, but the circulatory roadway and central island of roundabouts can be an obstruction to get around. Roundabouts should not be oversized, nor should complete street elements be eliminated, for the occasional permit vehicle. Instead, truck aprons should be used to accommodate oversize/overweight vehicles, while preserving the speed control design of the roundabout. In addition to truck aprons, removable signs or other removable features in the central island or around the circular path can help ensure that these trucks can navigate the roundabout.

When designing for the oversize/overweight permit vehicle passing through the roundabout and staying on the state highway, a larger design vehicle is needed to design the roundabout entries, circulating roadway, and exits. The minimum design permit vehicle to be used is a "CALTRANS OS OW HEAVY HAUL" as designated in AutoTURN. See Figure 405.10B for this design vehicle. In addition to accommodating truck off-tracking, truck aprons at central and splitter islands, the design should accommodate an oversize/overweight vehicle with 6 inches of vertical clearance to pass through the intersection as shown in Figure 405.10B. A curb at the back of the central island truck apron, if needed, should not impede the oversize/overweight vehicle's movements. Oversize/overweight vehicles are not required to stay in their own lane.

Figure 405.10B

Oversize/Overweight Design Vehicle-CALTRANS OS OW HEAVY HAUL

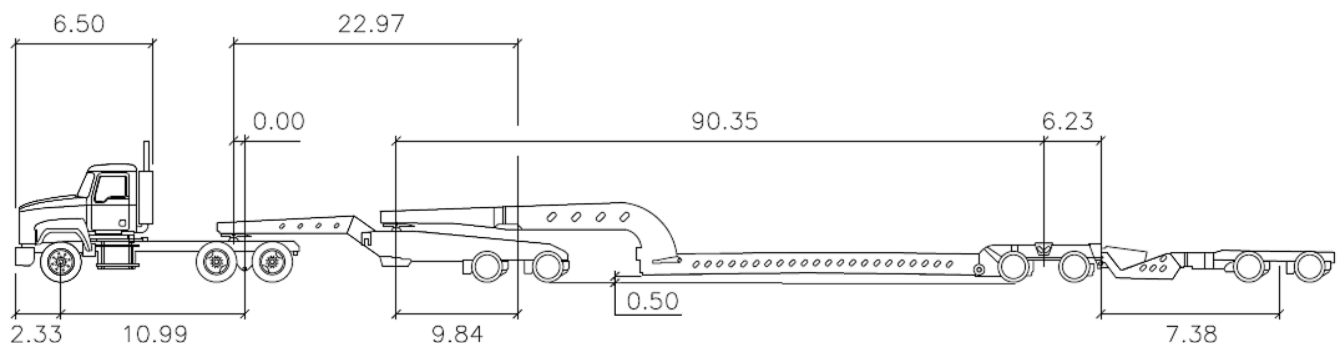

May 20, 2022

The design permit vehicle as discussed may not be the appropriate permit vehicle for design purposes. For example, local situations such as farm areas where wide farm equipment or long components for windmills near a windmill power facility may necessitate a special vehicle design to pass through the roundabout. Therefore, the designer must coordinate with the District Truck Access Manager to ascertain the oversize/overweight vehicles that are to be accommodated and any additional vehicle requirements. Designers should also work with the District Truck Access Manager to determine if the permit vehicles will have an alternative route to bypass the roundabout or if they have to pass through this intersection.

To accurately simulate the design vehicle swept width traveling through a roundabout, the minimum speed of the design vehicle used in computer simulation software (e.g., Auto TURN) should be less than 5 miles per hour through the roundabout. Tracking and swept width must not encroach onto sidewalks or pedestrian refuge areas.

- (3) *Inscribed Circle Diameter.* At single lane roundabouts, the size of the inscribed circle is largely dependent upon the turning requirements of the design vehicles. The inscribed circle diameter (ICD) must be large enough to accommodate: (a) the STAA design vehicle for all roundabouts on the National Network and on Terminal Access routes; and, (b) the California Legal design vehicle on all non-STAA route intersections on California Legal routes and California Legal KPRA Advisory routes, while maintaining adequate deflection curvature to ensure appropriate travel speeds for smaller vehicles. The non-permit design vehicle is to navigate the roundabout with the front tractor's wheels staying off the truck apron. The ICD for a single lane roundabout generally ranges between 105 feet to 150 feet to accommodate the California Legal design vehicle and 130 feet to 180 feet to accommodate the STAA design vehicle.

At multilane roundabouts, the ICD is to achieve adequate alignment of the natural vehicle path while maintaining deflection curvature to ensure appropriate travel speeds. To achieve both of these design objectives requires a slightly larger diameter than used for a single lane roundabout. The ICD for a multilane (2-lane) roundabout generally ranges between 150 feet to 220 feet to accommodate the California Legal design vehicle for non-STAA route intersections on California Legal routes and California Legal KPRA Advisory routes, and 165 feet to 220 feet to accommodate the STAA design vehicle for roundabouts on the National Network and on Terminal Access routes. Similar to a single lane roundabout, the non-permit design vehicle is to be able to navigate a multilane roundabout with the front tractor wheels staying off the truck apron.

A mini-roundabout may be an acceptable roundabout design on low volume routes or ramp terminals. With an inscribed circle diameter of less than 90 feet, the central island will need to be fully traversable to accommodate the design vehicles movements.

The ICD ranges given above are typical values; the design may be larger or smaller. Site location constraints and performance checks will determine if the diameter is appropriate for the location.

- (4) *Entry Speeds.* Lowering the speed of vehicles entering and traveling through the roundabout is a primary design objective that is achieved by approach alignment and entry geometry.

The following entry speeds should not be exceeded:

- Single lane entry, 25 miles per hour.
- Multilane entry, 30 miles per hour.

A bypass lane is not included in the number of entry lanes. Although, a bypass lane prohibits entry into the circulatory roadway, the bypass lane should also meet the speed requirements to ensure that diverge and merge speeds are within 10 mile per hour of each other and

vehicle speeds are not more than 20 mile per hours at pedestrian crossings. See Index 405.3(2)(b).

Entry speeds are to be determined through fastest path analysis. The fastest path is the smoothest, flattest path possible for a single vehicle in the absence of other traffic and ignoring all lane markings. The fastest path analysis should begin at least 165 feet from the ICD and should not bring the path closer than 3 feet from the edge of traveled way prior to the splitter island nor 5 feet from the face of a curb. These distances are minimums and the fastest path may occur further away from the curbs and striping depending on the roundabout configuration. For fastest path evaluation, see NCHRP Report 672, Section 6.7.1.

- (5) *Exit Design.* Similar to entry design, exit design flexibility is required to achieve the optimal balance between competing design variables and project objectives to provide adequate capacity and safety while minimizing excessive property impacts and costs. Thus, the selection of a curved versus tangential design is to be based upon the balance of each of these criteria. Exit design is influenced by the place type, pedestrian demand, bicyclist needs, the design vehicle and physical constraints. The exit curb curve radii are usually larger than the entry curb curve radii in order to minimize the likelihood of congestion and crashes at the exits. Larger exit curb curve radii may also be needed to develop adequate deflection on the adjacent entry. However, the desire to minimize congestion at the exits needs to be balanced with the need to maintain an appropriate operating speed through the pedestrian crossing.
- (6) *Number of Legs Serving the Roundabout.* Intersections with more than four legs are often difficult to manage operationally. Roundabouts are a proven traffic control device in such situations. However, it is necessary to ensure that the design vehicle can maneuver through all unrestricted legs of the roundabout. A public or private driveway as a leg to an intersection is not uncommon nor inappropriate and can be acceptable at non-interchange roundabouts as well. Driveways in and near proposed roundabouts should be included in the performance checks where applicable, including truck turning movements. For access control guidance at interchange ramp intersections, see Index 405.10 (13).
- (7) *Sidewalk and shared use path.* The sidewalk should be designed as a shared use path, since the path will serve both pedestrians and those bicyclists who are not comfortable taking the lane to proceed through the roundabout. Although the sidewalk is considered a shared use path, it does not need to meet the design standards in Index 1003, but it should meet the design standards within Index 405.10.
 - (a) *Pedestrian Use.* Sidewalks around the circular roadway are to be designed in accordance with guidance in Design Information Bulletin (DIB) 82 Pedestrian Accessibility Guidelines for Highway Projects but must also be designed to allow low-speed bicycles to circulate around the roundabout. In addition to the guidance in DIB 82, the following applies:
 - i. The detectable warning surface (truncated domes) alert a pedestrian that they are about to enter cross traffic and is required on curb ramps. They are not to be used on a bike ramp.
 - ii. Truck aprons and mountable curbs are not to be placed in or adjacent to pedestrian crossing areas to avoid confusing pedestrians on where the crossing begins.
 - iii. See the California MUTCD for the signs and markings used at roundabouts.
 - iv. At pedestrian crossing locations the accessibility design will be treated as a midblock pedestrian street crossing. See DIB 82 for more information. Pedestrian crossings may also be used by bicyclists; thus, these crossings need to be designed for both bicyclist and pedestrian needs and should be a minimum of 8 feet wide, 10 feet is preferred.

May 20, 2022

- v. A landscape buffer/strip, detectable by cane and under foot, between the sidewalk and the back of curb for the circular roadway of the roundabout should be a minimum of 2 feet wide, 3 feet is preferred. For more information see NCHRP Report 834, entitled "Crossing Solutions at Roundabout and Channelized Turn Lanes for Pedestrians with Vision Disabilities." See Figure 405.10C.

Figure 405.10C

Typical Cross Section of Buffer Between Sidewalk and Roundabout

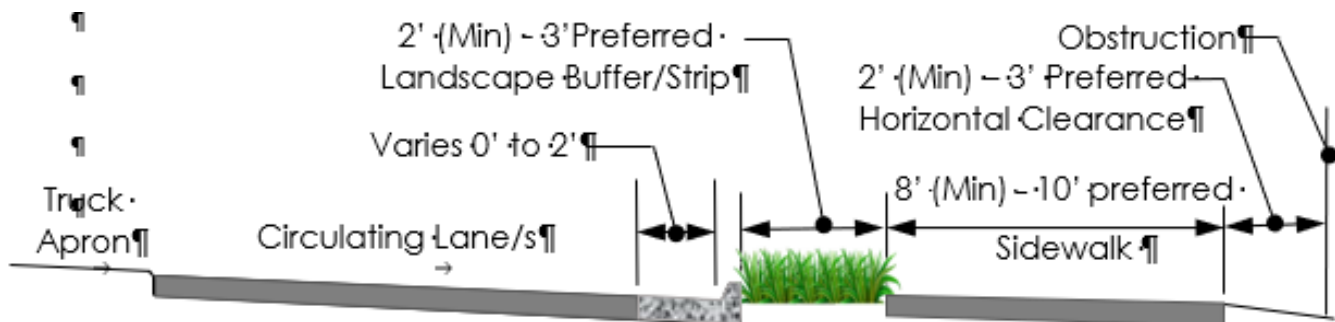

(b) *Bicyclist Use.* Bicyclists may choose to travel in the circular roadway of a roundabout by taking a lane, while others may decide to travel using the sidewalk to bypass the circular roadway. Therefore, the approach and circular roadways, as well as the sidewalk, need to be designed for the mobility needs of bicyclists.

- i. General. Bicycle ramps at roundabouts have the potential to be confused as pedestrian ramps, particularly for pedestrians who are visually impaired. The detectable warning surface (truncated domes) are not to be used on bike ramps.
- ii. Bicyclist Use of the Circular Roadway. A bicyclist approaching from the roadway shoulder needs to be provided a choice of merging left into the lane to traverse the roundabout in the circulating lane with the vehicles or using the bicycle ramp to use the sidewalk. Single lane roundabouts tend to be comfortable for most bicyclists to travel through. Even, multilane roundabouts, that require bicyclists to change lanes at the entry to the circular roadway to select the appropriate lane for their direction of travel, appear to be comfortable for bicyclists who prefer to travel in the traveled way.
- iii. Bicyclists Use of the Sidewalk. At roundabouts, bicyclists may ride around the roundabout using the sidewalk along with the pedestrians. This multi-modal situation introduces additional design considerations. The sidewalk is to be designed using the guidance in NCHRP Report 672 Section 6.8.2.2, the accessibility guidance in DIB 82, and the following:
 - To accommodate mounted cyclists and pedestrians, a sidewalk should be included and have a minimum paved width of 8 feet, 10 feet is preferred.
 - A minimum 2-foot horizontal clearance from the outside paved edge of the sidewalk to obstructions should be provided, 3 feet is preferred. Although not considered a shoulder, the surface should be flush with the edge of the sidewalk to allow bicyclists to recover. The surface material only needs to support the sidewalk pavement and minimize edge drop-off.

- Bicycle ramps are to be located to avoid being confused with curb ramps for pedestrians.
- The design details of the bicycle ramp are also important to the bicyclist. Bicycle ramps should be placed at a 35 to 45 degree angle to the departure roadway to enable the bicyclists to use the ramp while discouraging bicyclists from entering the sidewalk at a high speed.
- If there is a difference in the standards, the accessibility guidance in DIB 82 is to be followed to ensure the facility is accessible to pedestrians with disabilities.

(8) *Transit Use.* Transit vehicles and buses will not have difficulty negotiating a roundabout when it has been designed using the California Legal design vehicle or the STAA design vehicle. However, to minimize passenger discomfort, a roundabout should be designed such that the transit vehicle or bus does not use the truck apron.

(9) *Stopping Sight Distance and Visibility.* See NCHRP Report 672 Section 6.7.3 for stopping sight distance guidance at roundabouts.

A domed or mounded central island, between 3.5 to 6 feet high, is needed to focus attention on the approach and through roundabout alignment. A domed central island provides a visual screen to the downstream alignment and other distractions, and provides a visual cue for vehicles approaching the roundabout.

In high speed environments, additional lighting of, and vertical elements in the central island (i.e., landscaping and aesthetic features) may be needed.

(10) *Speed Consistency.* Consistency in operating speeds between the various movements within the roundabout can minimize collisions between traffic streams. The operating speeds between competing traffic streams and between consecutive geometric elements should be minimized such that the maximum speed differential between them is no more than 10 miles per hour.

(11) *Path Alignment (Natural Path).* As two traffic streams approach a multilane entry roundabout in adjacent lanes, drivers and bicyclists will be guided by lane markings up to the entrance line. At the yield point, they will continue along their natural trajectory into the circulatory roadway. The speed and orientation of the vehicle at the entrance line determines what can be described as its natural path. The geometry of the exits also affects the natural path that the vehicle travels. The natural path of two adjacent entering vehicles are not to overlap, see NCHRP Report 672, Section 6.7.2.

(12) *Splitter Islands.* Splitter islands (also called separator islands, divisional islands, or median islands) will be provided on all roundabouts. The purpose is to provide refuge for pedestrians, assist in controlling speeds, guide traffic into the roundabout, physically separate entering and exiting traffic streams, and deter wrong-way movements.

The total length of the raised island should be at least 50 feet although 100 feet is desirable. Additionally, the splitter island should extend beyond the end of the exit curve to prevent exiting traffic from crossing into the path of approaching traffic. The splitter island width should be a minimum of 6 feet at the pedestrian crossing to adequately provide refuge for pedestrians.

Roadways with posted speeds greater than or equal to 45 miles per hour, or at freeway exit ramps, require the splitter island lengths, as measured from the ICD, to be 200 feet. In some instances, a longer splitter island may be desirable. Concrete curb is to be provided on the right side of the approach roadway equal to the length of the splitter island.

May 20, 2022

At a low volume driveway leg of a roundabout, the splitter island may be eliminated if there would be no disruption to traffic flow.

(13)*Access Control.* The access control standards in Index 504.3(3) and 504.8 apply to roundabouts at interchange ramp intersections. The dimensions shown in Index 504.8 are to be measured from the ICD.

Driveways can occur within the roundabout or outside the access control. Driveways on approach and egress legs should not be placed within 50 feet from the ICD. Regarding crosswalk placement, consider the direction a driver exiting the driveway is looking for approaching traffic. Driveways should not be within 50 feet of a downstream crosswalk. At non-interchange roundabouts, a driveway may be added as a leg to a roundabout if supported operationally. Also consider if a driveway would be appropriate at that location if the intersection were eventually to become a signalized intersection.

(14)*Lighting.* Lighting is required at all roundabouts. See NCHRP Report 672 Chapter 8, the Traffic Manual Chapter 9 as well as consult with the District Traffic Safety Engineer.

(15)*Landscaping.* Landscaping should be designed such that drivers and bicyclists can observe the signing and shape of the roundabout as they approach, allowing adequate visibility for making decisions prior to and within the roundabout. The landscaping of the central island can enhance the intersection by making it a focal point, by promoting lower speeds and by breaking the headlight glare of oncoming vehicles or bicycles. It is desirable to create a domed or mounded central island, between 3.5 to 6 feet high, to increase the visibility of the intersection on the approach. Central island landscaping should provide elements that absorb kinetic energy of errant vehicles or redirect the vehicle, and not include features that may lead to the vehicle becoming airborne. Contact the District Landscape Architecture Unit to provide technical assistance in designing the roundabout landscaping. See Chapter 900 for additional Landscape Architecture requirements.

(16)*Vertical Clearance.* The vertical clearance guidance provided in Index 309.2 applies to roundabouts.

(17)*Drainage Design.* See Chapters 800 to 890 for further guidance.

(18)*Maintenance.* Contact the District Maintenance Engineer and appropriate Regional Manager for maintenance strategies and practices, including seasonal operations, maintenance resources, and specialized equipment. Maintenance responsibilities may also include multiple state, county, and city agencies where coordination of maintenance efforts and funding is needed.

Consider maintenance of the central island. Provide a maintenance vehicle pullout within the central island beyond the truck apron, so maintenance vehicles will not conflict with circulating trucks, see Figure 405.10A.

(19)*Snow Areas.* In climate regions where snowfall requires the use of snow removal equipment, consider the equipment to be used. Design ICD's as well as entrance and exit geometry to accommodate snow removal equipment and plow limitations. Check with District Maintenance for their requirements and limitations. Geometric elements to consider that facilitate snow removal are; mountable curb, tapering the ends of curbs down to allow plows to ride over curbs, plowing accommodation in both directions, providing snow storage space within the central island, and providing minimum entry/exit widths to accommodate the plow blade. Mountable curb may be used if the sidewalk/shared use path is not contiguous to the curb. Provide a planter or textured pavement between the path and the roadway. Snow storage areas must be designed to prevent snow melt from entering the circulating lanes where it can freeze. Snow storage areas must not block pedestrian paths.

- (20) *Utilities*. Utility access openings (manholes) should not be located within the traveled way within the boundary of the roundabout. Roundabouts do not have shoulders to accommodate traffic while manholes are accessed. Manholes should not be allowed within the circulating roadway to avoid closing down the intersection during access. If a manhole is absolutely necessary within the boundary of the ICD, place it in the central island and off of the truck apron. Provide a maintenance vehicle pullout to allow access to the manhole without blocking truck traffic, see Figure 405.10A.
- (21) *Performance Checks*. Roundabout design is not standard-based; it is a performance-based design method, which uses an iterative design process. As the design progresses through performance checks, as outlined in NCHRP Report 672, the geometrics of the design is refined. Any roundabout design submitted for geometric review without completed performance checks is an incomplete design. A roundabout design submitted for review during the Project Approval or Plan, Specification and Estimate phases must be accompanied by completed performance checks. However, a roundabout design submitted for review during the Project Initiation phase does not require completed performance checks.
- (22) *Turbo Roundabouts*. Some multilane roundabouts experience higher than expected frequencies of sideswipe collisions. To prevent this, some countries have implemented a modified version of a multilane roundabout called the turbo roundabout. The significant differences between turbo roundabouts and modern roundabout are that a physical separation is included to prevent lane changes within the circulating lanes of the turbo roundabout. This separation results in a larger roundabout footprint with little to no deflection on entry and with all vehicles staying completely within their lane. To date there are only a few hundred worldwide and less than five in the US and Canada combined; consequently, there is limited information regarding the design of turbo roundabouts, especially regarding North American driver and vehicles. The traditional capacity analysis tools for roundabouts do not apply to turbo roundabouts. Due to the limited experience in the U.S. and lack of analysis tools, caution should be used before selecting a turbo roundabout for an intersection alternative on the State highway system.

Turbo roundabout intersections on the State highway system should be developed and evaluated in accordance with the following: The FHWA Safety Program Informational Primer entitled “Turbo Roundabouts;” NCHRP Report 672 “Roundabouts: An Informational Guide;” “Roundabouts-Application and Design, A Practical Manual,” from the Dutch Ministry of Transport, Public Works and Water Management, Partners for Roads; and, TOPD Number 13-02 “Intersection Control Evaluation.” Per FHWA’s recommendation for capacity analysis of turbo roundabouts, refer to Transportation Research Record (TRR) Issue Number 2517-08 entitled “Capacity Estimation on Turbo roundabouts with Gap Acceptance and Flow Level Methods.” Also see Index 401.5 for general information and guidance.

Topic 406 – Ramp Intersection Capacity Analysis

The following procedure for ramp intersection analysis may be used to estimate the capacity of any signalized intersection where the phasing is relatively simple. It is useful in analyzing the need for additional turning and through traffic lanes. For a more complete analysis refer to the Highway Capacity Manual.

- (a) *Ramp Intersection Analysis*--For the typical local street interchange there is usually a critical intersection of a ramp and the crossroads that establishes the capacity of the interchange. The capacity of a point where lanes of traffic intersect is 1500 vehicles per hour. This is

May 20, 2022

expressed as intersecting lane vehicles per hour (ILV/hr). Table 406 gives values of ILV/hr for various traffic flow conditions.

If a single-lane approach at a normal intersection has a demand volume of 1000 vph, for example, then the intersecting single-lane approach volume cannot exceed 500 vph without delay.

The three examples that follow illustrate the simplicity of analyzing ramp intersections using this 1500 ILV/hr concept.

- (b) Diamond Interchange--The critical intersection of a diamond type interchange must accommodate demands of three conflicting travel paths. As traffic volumes approach capacity, signalization will be needed. For the spread diamond (Figure 406A), basic capacity analysis is made on the assumption that 3-phase signalization is employed. For the tight diamond (Figure 406B), it is assumed that 4-phase signal timing is used.
- (c) 2 Quadrant Cloverleaf--Because this interchange design (Figure 406C) permits 2-phase signalization, it will have higher capacities on the approach roadways. The critical intersection is shared two ways instead of three ways as in the diamond case.

Table 406

Vehicle Traffic Flow Conditions at Intersections at Various Levels of Operation

<i>ILV/hr</i>	Description
<hr/>	
<i>< 1200:</i>	Stable flow with slight, but acceptable delay. Occasional signal loading may develop. Free midblock operations.
<hr/>	
<i>1200-1500:</i>	Unstable flow with considerable delays possible. Some vehicles occasionally wait two or more cycles to pass through the intersection. Continuous backup occurs on some approaches.
<hr/>	
<i>1500 (Capacity):</i>	Stop-and-go operation with severe delay and heavy congestion ⁽¹⁾ . Traffic volume is limited by maximum discharge rates of each phase. Continuous backup in varying degrees occurs on all approaches. Where downstream capacity is restrictive, mainline congestion can impede orderly discharge through the intersection.

NOTE:

The amount of congestion depends on how much the ILV/hr value exceeds 1500. Observed flow rates will normally not exceed 1500 ILV/hr, and the excess will be delayed in a queue.

May 20, 2022

Figure 406A

Spread Diamond

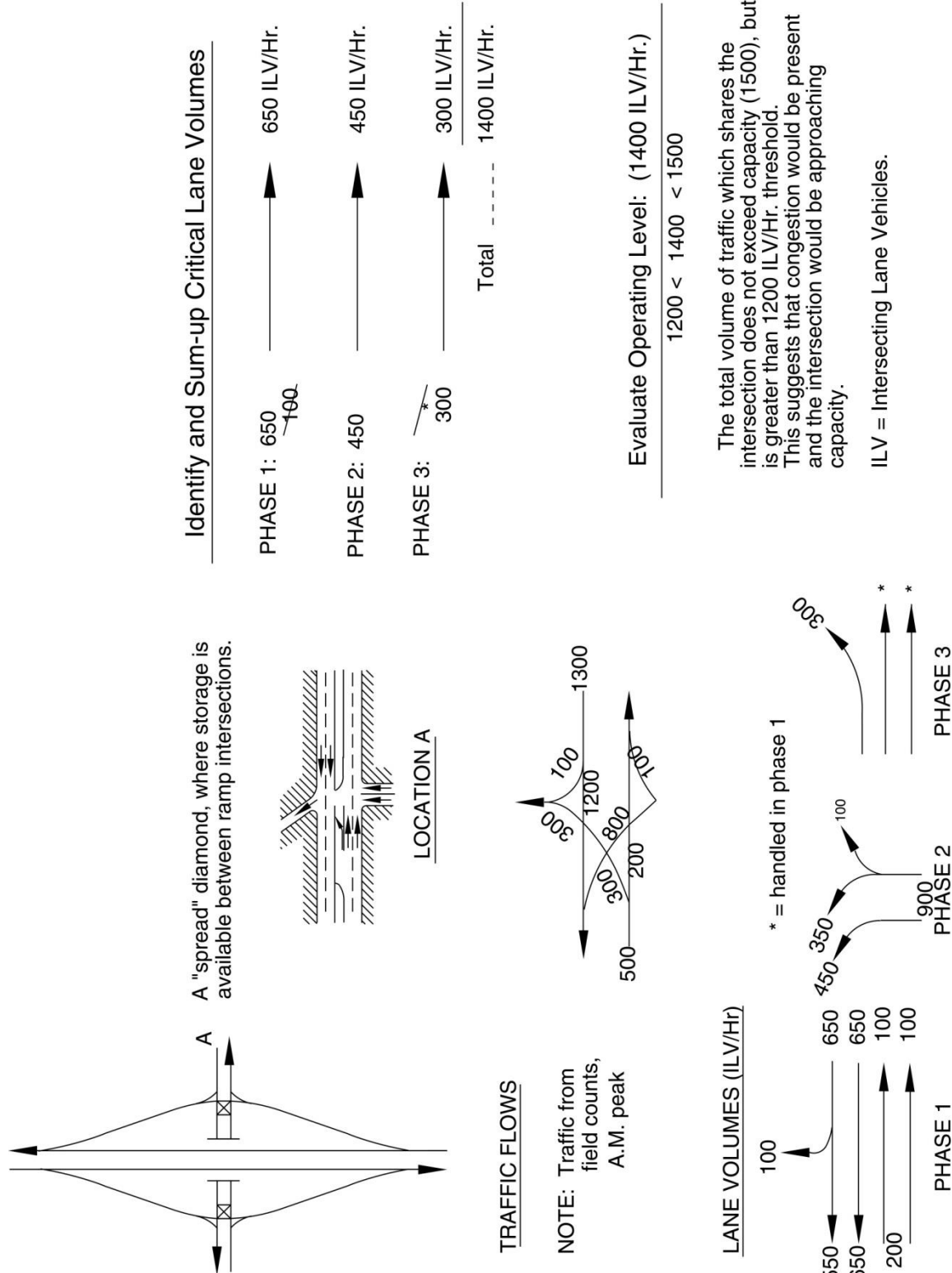
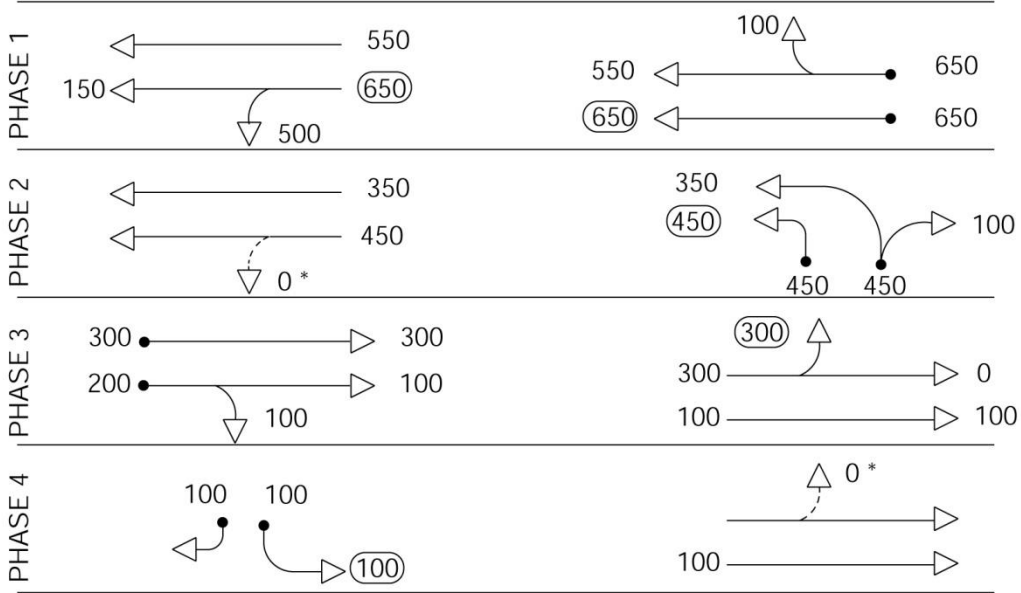
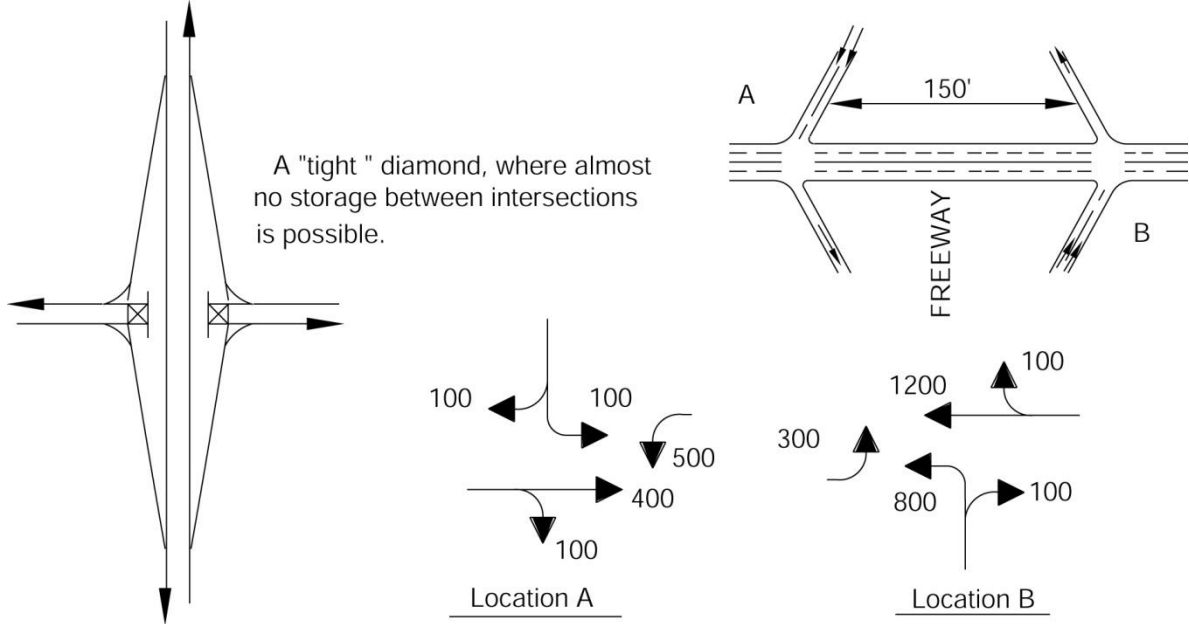

Figure 406B

Tight Diamond



*NOTE: When no storage at all is permitted, left-turn movement is cleared during this phase.

Critical Lane Volumes: 650
450
300

ILV=Intersecting Lane Vehicles. 100
1500 ILV/Hr.

May 20, 2022

Figure 406C

Two-quadrant Cloverleaf

